

**Owner's/User's Manual**



**Serial Number C34850 - Current**

**Systems, LLC** • Poweramp • McGuire • DLM • W194 N11481 McCormick Drive • Germantown, WI 53022  
800.643.5424 • fax: 262.255.5917 • [www.loadingdocksystems.com](http://www.loadingdocksystems.com) • [techservices@loadingdocksystems.com](mailto:techservices@loadingdocksystems.com)

Printed in U.S.A.  
©2020 Systems, LLC - All Rights Reserved

Manual No. 4111-0093  
Nov. 2020

# Table of Contents

	Page		Page
<b>Precautions</b>		<b>Maintenance</b>	
Recognize Precautionary Information.....	1	Fault History .....	52
General Operational Precautions .....	1	Door Code Counters .....	53
Operational Precautions .....	2	Door Code History.....	53
Owner's/User's Responsibilities.....	4	Maintenance Entry .....	53
		Maintenance Records .....	55
<b>Introduction</b>		<b>Troubleshooting</b>	
General Information .....	6	Diagnostics .....	58
Component Identification .....	7	Multi-Colored Light .....	60
Definitions .....	8	Restraint/Leveler/Door Interlocking Options.....	62
		iDock Fault Codes .....	64
<b>Installation</b>		• System Faults.....	65
Installation Precautions.....	10	• Dock Leveler Faults .....	66
Mounting Control Panel.....	10	• TPR/UniLock Restraint Faults .....	67
Install Outside Light Assembly and Signs .....	11	• PowerStop/Stop-Tite Restraint Faults .....	68
System Configuration .....	12	• PowerHold/Hold-Tite Restraint Faults .....	69
System Settings .....	14	• PowerHook Restraint Faults.....	70
• User Language .....	14	LiftMaster® MAS Codes .....	72
• Change User Bypass Code.....	14		
• Change Maintenance Code.....	14	<b>Parts</b>	
• Timers .....	15	LiftMaster MAS Integration Retrofit Kit.....	73
• Lights & Sound .....	15	External Components .....	74
• Date & Time .....	15	Internal Components .....	75
• Network Connection .....	15	Terminal/Expansion Boards .....	76
• Program Access.....	17	OSLA (Outside Light Assembly).....	77
• Restraint Use.....	17	Signs.....	78
<b>Operation</b>		<b>Miscellaneous</b>	
Operational Precautions.....	18	iDock Sensors .....	80
System Boot & User Code Entry .....	19	iDock Connect .....	82
Main Menu .....	20	Customer Information.....	83
Dock Alert/LCS .....	22	Warranty .....	Back Cover
Dock Alert/LCS w/Pit or HED Leveler.....	24		
Dock Alert/LCS w/Pit Leveler and Lip Out.....	28		
Dock Alert/LCS w/Vertical Leveler.....	30		
Vehicle Restraint .....	34		
Pit or HED Leveler w/Vehicle Restraint.....	38		
Pit Leveler w/Lip Out & Vehicle Restraint.....	42		
Vertical Leveler w/Vehicle Restraint.....	44		
Optional Equipment .....	48		
Communication Lights.....	50		

## Recognize Precautionary Information

### Safety-Alert Symbol



The Safety-Alert Symbol is a graphic representation intended to convey a safety message without the use of words. When you see this symbol, be alert to the possibility of death or serious injury. Follow the instructions in the safety message panel.

### **DANGER**

The use of the word DANGER signifies the presence of an extreme hazard or unsafe practice which will most likely result in death or severe injury.

### **WARNING**

The use of the word WARNING signifies the presence of a serious hazard or unsafe practice which could result in death or serious injury.

### **CAUTION**

The use of the word CAUTION signifies possible hazard or unsafe practice which could result in minor or moderate injury.

### **NOTICE**

The use of the word NOTICE indicates information considered important, but not hazard-related, to prevent machine or property damage.

## **SAFETY INSTRUCTIONS**

Indicates a type of safety sign, or separate panel on a safety sign, where safety-related instructions or procedures are described.

## General Operational Precautions

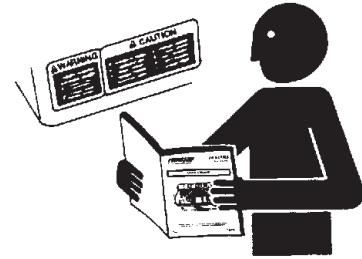

Read and understand the Owner's/User's Manual and become thoroughly familiar with the equipment and its controls before operating the equipment.

Never operate dock equipment while a safety device or guard is removed or disconnected.

Never remove DANGER, WARNING, or CAUTION signs, Placards or Decals on the equipment unless replacing them.



**WARNING:** This product can expose you to chemicals including lead, which are known to the State of California to cause cancer or birth defects or other reproductive harm. For more information go to [www.P65Warnings.ca.gov](http://www.P65Warnings.ca.gov)

# PRECAUTIONS

## Operational Precautions



Learn the safe way to operate this equipment. Read and understand the manufacturer's instructions. If you have any questions, ask your supervisor.

### **DANGER**



Stay clear of dock leveling device when transport vehicle is entering or leaving area.



Do not move or use the dock leveling device if anyone is under or in front of it.



Keep hands and feet clear of pinch points. Avoid putting any part of your body near moving parts.

### **WARNING**



Chock/restrain all transport vehicles. Never remove the wheel chocks or release the restraining device until loading or unloading is finished, and transport driver has been given permission to drive away.



Do not use a broken or damaged dock leveling device or restraining device. Make sure proper service and maintenance procedures have been performed before using.

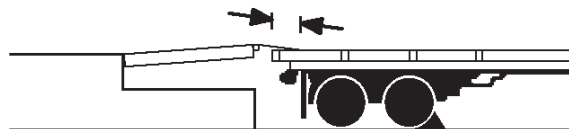

Make sure lip overlaps onto transport vehicle bed at least 4 in. (102 mm).

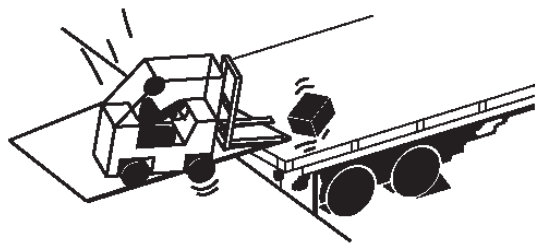

Keep a safe distance from both side edges.



**Operational Precautions**

**! WARNING**

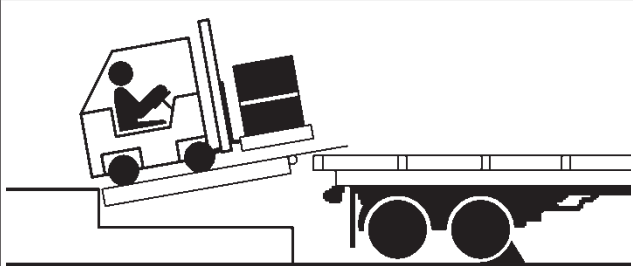

Do not use dock leveling device if transport vehicle is too high or too low.

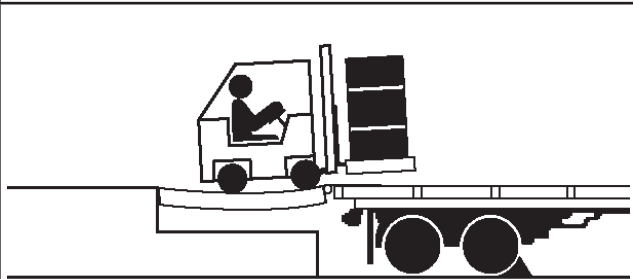

Do not overload the dock leveling device.

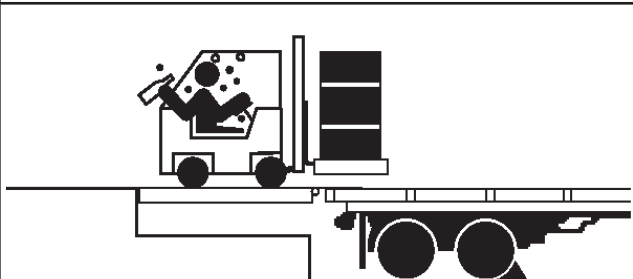

Do not operate any equipment while under the influence of alcohol or drugs.

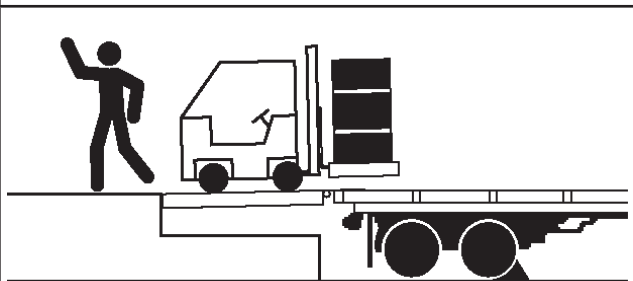

Do not leave equipment or material unattended on dock leveling device.

# OWNER'S/USER'S RESPONSIBILITIES

---

- 1) The manufacturer shall provide to the initial purchaser and make the following information readily available to the owners/users and their agents, all necessary information regarding Safety Information, Operation, Installation and Safety Precautions, Recommended Initial and Periodic Inspections Procedures, Planned Maintenance Schedule, Product Specifications, Troubleshooting Guide, Parts Break Down, Warranty Information, and Manufacturers Contact Information, as well as tables to identify the grade(slope) for all variations of length or configuration of the dock leveling device and information identifying the maximum uncontrolled drop encountered when sudden removal of support while in the working range of the equipment.
- 2) When selecting loading dock safety equipment, it is important to consider not only present requirements but also future plans and any possible adverse conditions, environmental factors or usage. The owners/users shall provide application information to the manufacturer to receive recommendations on appropriate equipment specifications and capacity.
- 3) The owner/user must see all nameplates, placards, decals, instructions and posted warnings are in place and legible and shall not be obscured from the view of the operator or maintenance personnel for whom such warnings are intended for. Contact manufacturer for any replacements.
- 4) Dock leveling devices may become hazardous if the manufacturer's instructions regarding modifications or adjustments are not followed. Modifications or alterations of dock leveling devices shall only be made with prior written approval from the original manufacturer. These changes shall be in conformance with all applicable provisions of the MH30.1 standard and shall also satisfy all safety recommendations of the original equipment manufacturer of the particular application.
- 5) Modifications or alterations of restraining devices shall be made only with prior written approval from the original manufacturer. These changes shall be in conformance with all applicable provisions of the MH30.3 standard and shall also satisfy all safety recommendations of the original equipment manufacturer of the particular application.
- 6) The owner/user should recognize the inherent dangers of the interface between the loading dock and the transport vehicle. The owner/ user should, therefore, train and instruct all operators in the safe operation and use of the loading dock equipment in accordance with manufacturer's recommendations and industry standards. Effective operator training should also focus on the owner's/ user's company policies, operating conditions and the manufacturer's specific instructions provided with the dock leveling device. Maintaining, updating and retraining all operators on safe working habits and operation of the equipment, regardless of previous experience, should be done on a regular basis and should include an understanding and familiarity with all functions of the equipment. Owners/users shall actively maintain, update and retrain all operators on safe working habits and operations of the equipment.
- 7) An operator training program should consist of, but not necessarily be limited to, the following:
  - a) Select the operator carefully. Consider the physical qualifications, job attitude and aptitude.
  - b) Assure that the operator reads and fully understands the complete manufacturer's owners/ users manual.
  - c) Emphasize the impact of proper operation upon the operator, other personnel, material being handled, and equipment. Cite all rules and why they are formulated.
  - d) Describe the basic fundamentals of the dock leveling device and components design as related to safety, e.g., mechanical limitation, stability, functionality, etc.
  - e) Introduce the equipment. Show the control locations and demonstrate its functions. Explain how they work when used properly and maintained as well as problems when they are used improperly.
  - f) Assure that the operator understands the capacity rating, nameplate data, placards and all precautionary information appearing on the dock leveling device.
  - g) Supervise operator practice of equipment.
  - h) Develop and administer written and practical performance tests. Evaluate progress during and at completion of the course.
  - i) Administer periodic refresher courses. These may be condensed versions of the primary course and include on-the-job operator evaluation.
- 8) Loading dock safety equipment should never be used outside of its vertical working range, or outside the manufacturer's rated capacity. It shall also be compatible with the loading equipment and other conditions related to dock activity.

# OWNER'S/USER'S RESPONSIBILITIES

---

Please consult the manufacturer if you have any questions as to the use, vertical working range or capacity of the equipment. Only properly trained and authorized personnel should operate the equipment.

- 9) It is recommended that the transport vehicle is positioned as close as practical to the dock leveling device and in contact with both bumpers. When an industrial vehicle is driven on or off a transport vehicle during loading and unloading operations, the transport vehicle parking brakes shall be applied and wheel chocks or a restraining device that provides equal or better protection of wheel chocks shall be engaged. Also, whenever possible, air-ride suspension systems should have the air exhausted prior to performing said loading and unloading operations.
- 10) When goods are transferred between the loading dock and a trailer resting on its support legs/ landing gear instead of a tractor fifth wheel or converter dolly, it is recommended that an adequate stabilizing device or devices shall be utilized at the front of the trailer.
- 11) In order to be entitled to the benefits of the standard product warranty, the dock safety equipment must have been properly installed, maintained and operated in accordance with all manufacturer's recommendations and/or specified design parameters and not otherwise have been subject to abuse, misuse, misapplication, acts of nature, overloading, unauthorized repair or modification, application in a corrosive environment or lack of maintenance. Periodic lubrication, adjustment and inspection in accordance with all manufacturers' recommendations are the sole responsibility of the owner/user.
- 12) Manufacturer's recommended maintenance and inspection of all dock leveling and vehicle restraining devices shall be performed in conformance with the following practices: A planned maintenance schedule program must be followed, only trained and authorized personnel shall be permitted to maintain, repair, adjust and inspect dock leveling devices, and only the use of original equipment manufacturer parts, manuals, maintenance instructions, labels, decals and placards or their equivalent. Written documentation of maintenance, replacement parts or damage should be kept. In the event of damage, notification to the manufacturer is required.
- 13) Loading dock devices that are structurally damaged or have experienced a sudden loss of support while under load, such as might occur when a transport vehicle is pulled out from under the dock leveling device, shall be removed from service, inspected by a manufacturer's authorized representative, and repaired or replaced as needed or recommended by the manufacturer before being placed back in service.
- 14) Restraining devices that are structurally damaged shall be removed from service, inspected by a manufacturer's authorized representative, and repaired or replaced as needed or recommended by the manufacturer before being placed back in service.

# INTRODUCTION

## General Information



This manual provides current information on the iDock™ Control System. Due to ongoing product improvement, some parts may have changed, along with operation and troubleshooting methods. This manual describes these changes where applicable.

The iDock Control System is a technologically advanced push-button controller and light communication system used with Systems, LLC loading dock equipment.

iDock Control Systems feature a modular design. A 3-in-1 inside light assembly shows the state of the system and whether it is safe to enter the transport vehicle. A LCD display shows status of controls and explains fault conditions. Metal dome buttons provide positive control feedback.

Each iDock Control System has been factory tested to ensure satisfactory operation.

To illustrate which connections are to be made in the field at installation, electrical drawings are included with each order or by contacting Systems, LLC Technical Services.

iDock Control Systems are available in the following models:

### **iDock**

- Dock Alert/Light Communication System
- Pit or HED Leveler
- Pit Leveler w/Lip Out
- Vertical Leveler
- Vehicle Restraint
- Pit or HED Leveler w/Vehicle Restraint
- Pit Leveler w/Lip Out & Vehicle Restraint
- Vertical Leveler w/Vehicle Restraint

### **Optional Equipment**

- CentraPower® (Poweramp® only)
- Overhead Door Controls
- Emergency Stop
- Dock Light
- Edge Lights
- Fluid Level Sensor
- Fork Lift Truck Counter
- Outside Vehicle Presence
- Guide Lights
- Door Fault/Maintenance Notification

Call Systems, LLC to discuss available options to meet your specific needs.

**Technical Service at 800-643-5424 or [techservices@loadingdocksystems.com](mailto:techservices@loadingdocksystems.com)**

## Component Identification

Inspect package and all components. Ensure enclosure, lenses, push button membranes, wiring and circuit boards are intact. Report any scratches, dents, damage or missing items immediately and note on the shipping Bill Of Lading (BOL).

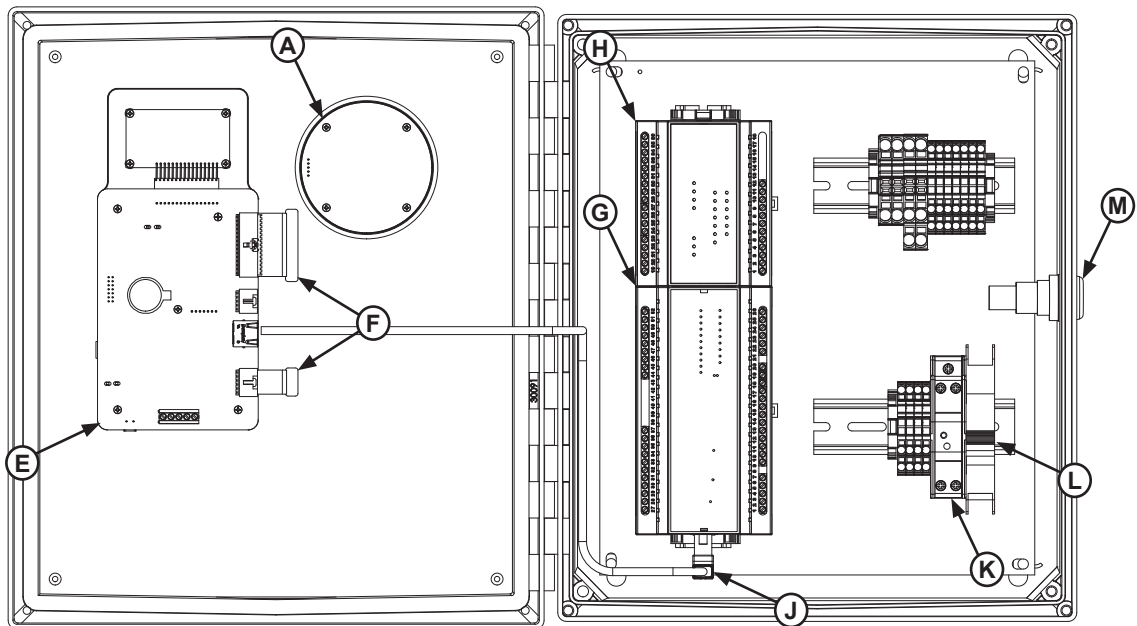
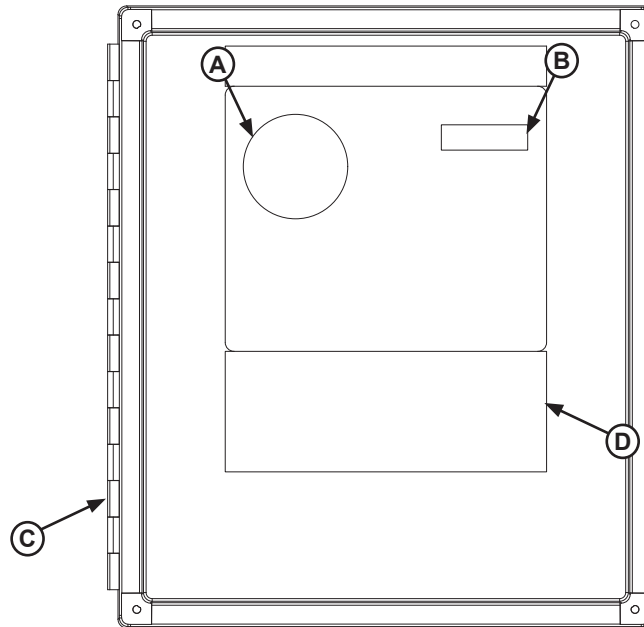

A — Multi-Colored LED Light  
B — Message Display  
C — Enclosure\*

D — Pushbutton Membrane\*  
E — Main Board Assembly  
F — Ribbon Cables

G — Terminal Board\*  
H — Expansion Board\*  
J — RJ45 Cable

K — Power Supply\*  
L — Circuit Breaker  
M — Alarm

\*Appearance may vary depending on options.

# INTRODUCTION

---

## Definitions

Throughout this manual, many different button inputs and system functions of the iDock Control System are referenced. This section defines these inputs/functions:

- **(A) DOCK ALERT STATUS BUTTON** - To change the status of the Dock Alert light communication system.
- **(B) ENGAGE BUTTON** - To activate vehicle restraint to capture transport vehicle RIG.
- **(C) RELEASE BUTTON** - To disengage vehicle restraint from transport vehicle RIG.
- **(D) RAISE BUTTON** - To activate dock leveler from a lowered or stored position.
- **(E) LOWER BUTTON** - To activate dock leveler from a raised position.  
**(VS and VSH models only)**
- **(F) LIP BUTTON** - To control the lip position.  
**(VS and VSH models only)**
- **(G) LIP OUT BUTTON** - To control the lip position.
- **(H) MENU BUTTON** - To access the iDock Control menus.
  - Press to activate menu screen.
  - Press to exit to previous screen.
- **(J) ENTER BUTTON** - To select highlighted feature or digit on the Message Display (**M**).
  - To save any setting changes.
- **(K) SCROLL UP/DOWN BUTTONS** - To change the message on display.
  - To change highlighted digit value.
  - To change the selected sub-menu.
- **(L) LEVELER STORED LIGHT** - The light that informs the user that the dock leveler is stored.  
**(VS and VSH models only)**
- **(M) MESSAGE DISPLAY** - During equipment operation, will show messages to assist the operator.
  - When menu is active, will show various settings, equipment info, and maintenance features.
- **Main Menu** - The menu that is accessed by pressing the MENU button (**H**). See page 20 for more information.
- **User Code** - Used to secure access to BYPASS mode. No code is default from factory. Owner/User is responsible to define 3-digit code if required; this code can be added or changed at any time. See page 14 for more information.
- **Maintenance Code** - Used to secure access to the MAINTENANCE menu. No code is default from factory. Owner/User is responsible to define 8-digit code if required; this code can be added or changed at any time. See page 14 for more information.

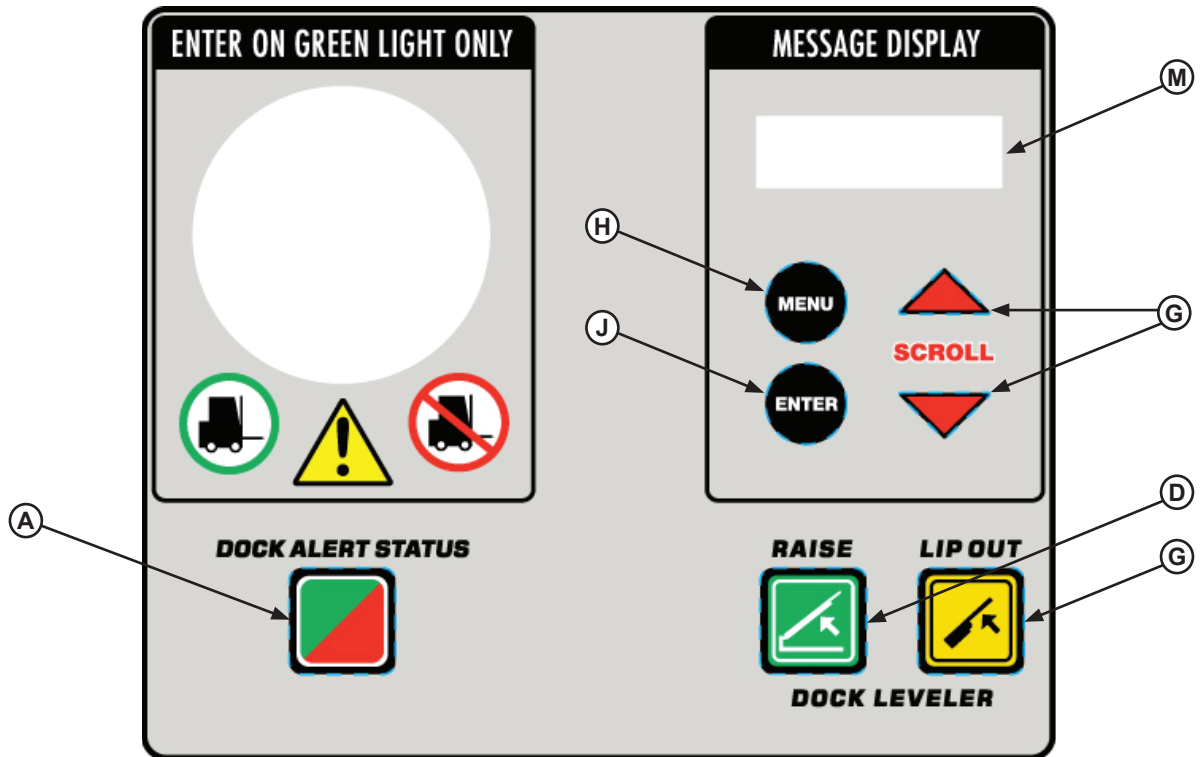

Dock Alert w/Pit Leveler and Lip Out

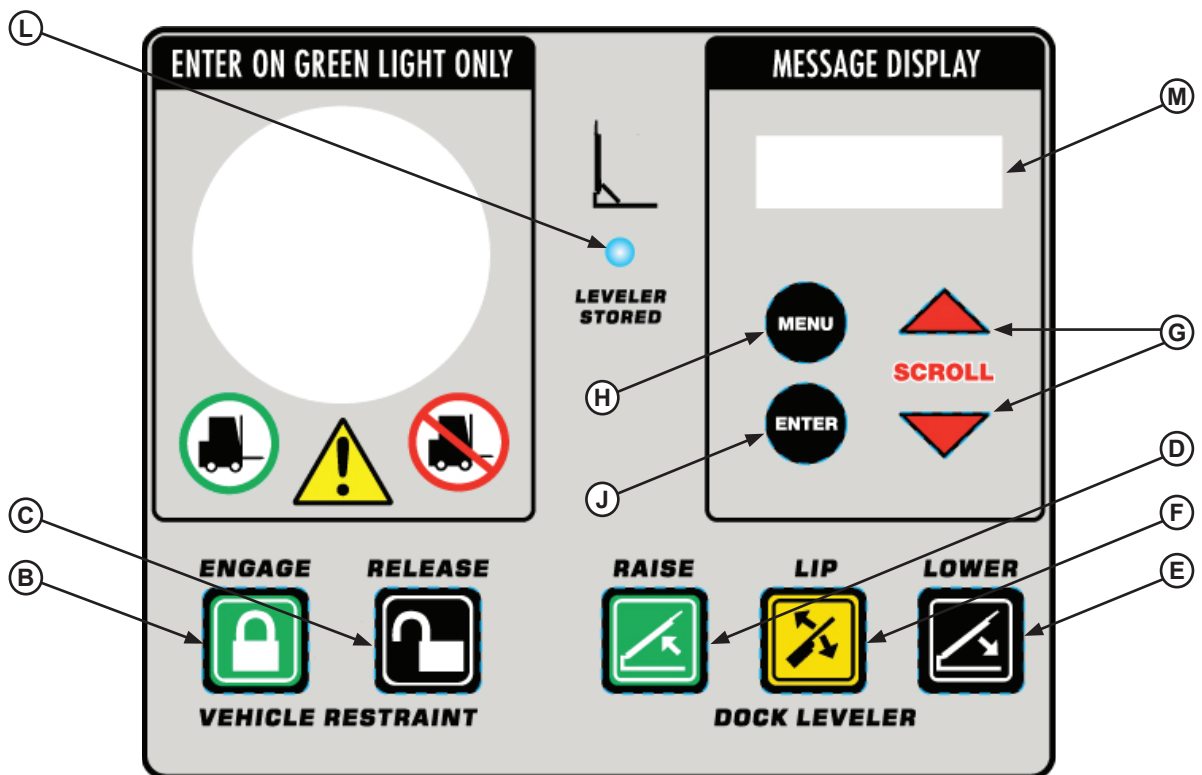

Vertical Leveler w/Vehicle Restraint



# INSTALLATION

## Installation Precautions

### **⚠ DANGER**

Make sure that the power source has been locked out and tagged according to OSHA regulations and approved local electrical codes.

### **⚠ WARNING**

A hard hat or other applicable head protection should always be worn when working under or around a dock leveler.

Always stand clear of platform lip when working in front of the dock leveler.

### **⚠ CAUTION**

All electrical work — including the installation of the disconnect panel, control panel, and final connections to the pit junction box — must be performed by a certified electrician and conform to all local and applicable national codes.

### **⚠ CAUTION**

Overhead door operators capable of remote operation can bypass iDock controller door interlock(s) when operated remotely! Always utilize the dry contact interlock terminals in the controller to provide the requisite signal and prevent remote door operation until the equipment is not in use.

### **NOTICE**

DO NOT connect any dock equipment electrical wiring or ground connections until all welding has been completed.

Failure to follow these instructions may damage the motor, hydraulics, wiring, and/or control panel.

### **NOTICE**

Where indicated, all components must be connected to a SAFETY EARTH GROUND that conforms to the 1999 National Electrical Code Section 250-50 section (a) or section (c) for a grounding electrode system.

## Mounting Control Panel

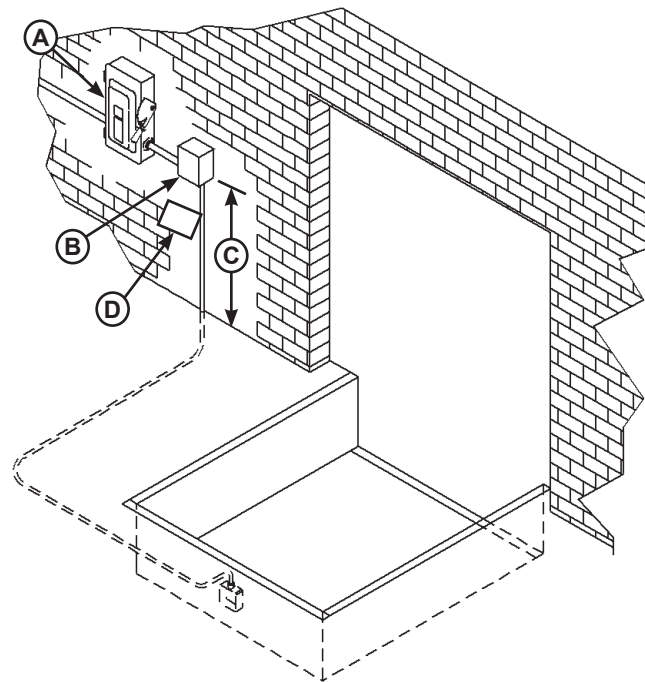

**A**— Disconnect Panel (provided by others)  
**B**— Control Panel  
**C**— Distance, 48 in. (1219 mm)  
**D**— Placard

1. Mount the control panel (**B**) so bottom of control panel-to-dock floor distance is 48 in. (1219 mm, **C**).
2. Install electrical disconnect panel (**A**) if not already installed (provided by others). It is recommended to locate disconnect panel adjacent to control panel (**B**).
3. Install and connect the control wiring as shown in installation drawings.
4. Connect the control wiring to the field wires in the dock equipment junction boxes. Refer to the electrical diagrams supplied with the dock equipment.

**Note:** When installing electrical controls in a temperature-controlled environment, the installer must determine an appropriate means to isolate/prevent thermal and vapor transfer through electrical conduit where conduit routing crosses temperature zones. Systems, LLC is not responsible for any damage due to moisture collecting inside the control panel caused by improper isolation/prevention of thermal and vapor transfer through the conduit. Refer to Tech Service Bulletin 19-053 for more information.

5. Install placard (**D**). Make sure placard is in plain view of dock leveler and/or vehicle restraint operations. Suggested placement of placard is near control box attached to electrical conduit by using nylon cable tie.

## Install Outside Light Assembly and Signs

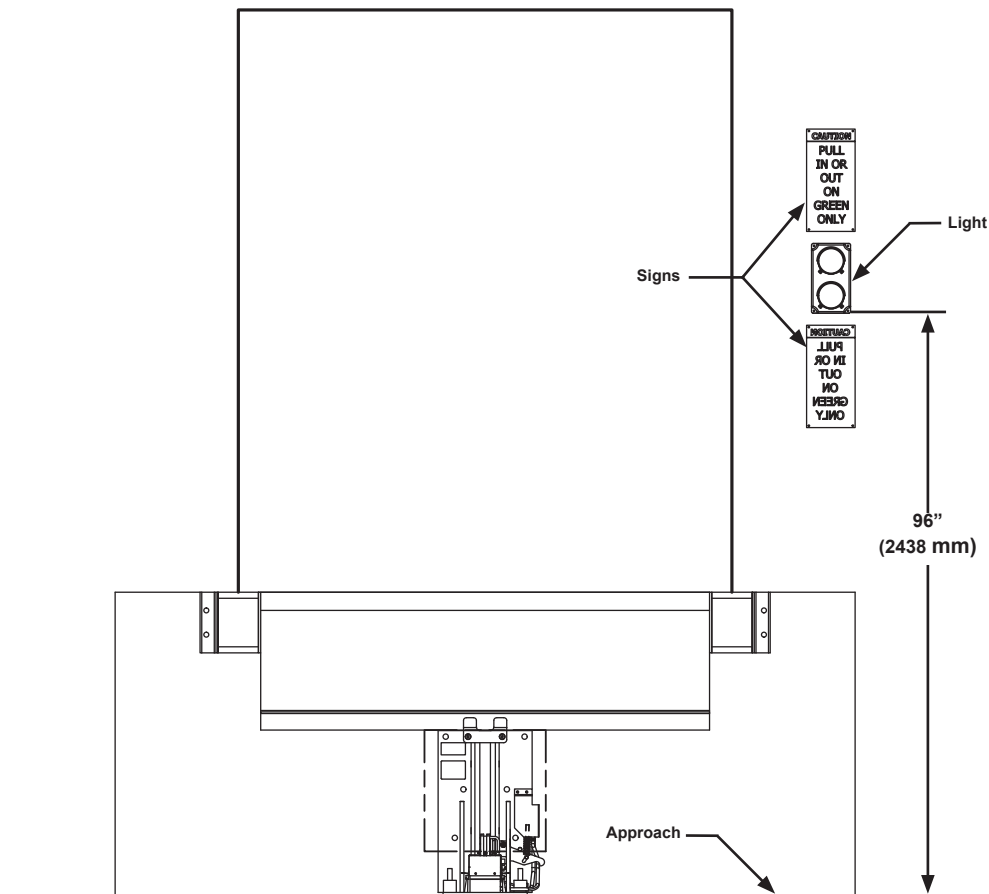

**Note:** Installation measurements shown are recommended based on typical dock conditions. Some installations may require alternate placement.

1. Mount the Outside Light Assembly so bottom of outside light-to-drive distance is 96 in. (2438 mm).
2. Connect the wiring for the Outside Light Assembly.
3. Install "CAUTION: PULL IN OR OUT ON GREEN ONLY" signs on outside of building above and below Outside Light Assembly.
4. Install "CAUTION: ENTER ON GREEN ONLY" sign inside building near control box.
5. Proceed with System Configuration (page 12).

## NOTICE

**The iDock Control System is designed to function with 12v DC outside lights only.**

Using 115v AC or other non-12v DC outside lights and wiring will cause the iDock Control System to enter a fault state and equipment will not function.

If 12v DC outside lights are already present and functioning, they can be re-used, but new wiring should always be run to ensure correct operation.

# INSTALLATION

## System Configuration

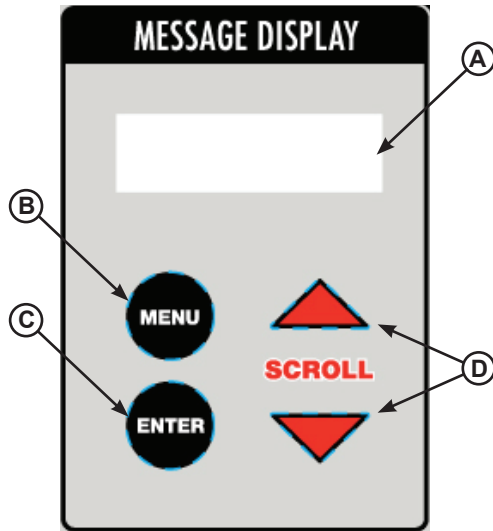

System Control Buttons/Displays

- A - Message Display
- B - MENU button
- C - ENTER button
- D - SCROLL UP/DOWN buttons

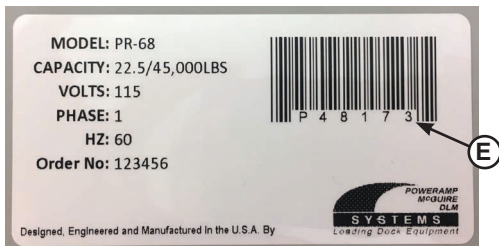

Systems, LLC Serial Number Decal

E - Serial Number

### Enter New Equipment Information

1. Turn system power ON with external disconnect:

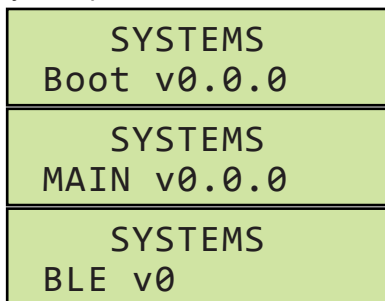

(alternating messages)

**Note:** (Versions referenced above will vary based on manufacturing date.)

2. Configure the iDock Control System by using the SCROLL UP/DOWN buttons (D) to change digit value and ENTER button (C) to move to the next digit or screen:

**Restraint:** Enter the vehicle restraint serial number as shown on the Systems, LLC label underneath the barcode (E). **Use a zero for the first digit if your serial number is only five digits:**

RESTRAINT S/N  
P \_\_\_\_\_

**Leveler:** Enter the dock leveler serial number as shown on the Systems, LLC label underneath the barcode (E). **Use a zero for the first digit if your serial number is only five digits:**

LEVELER SN  
P \_\_\_\_\_

**Door:** Enter door number and position as required:

DOOR NUMBER  
\_\_\_\_\_

---

DOOR POSITION  
\_\_\_\_\_

- Any door number up to 4 digits can be entered, and position can be selected from the following:

- SHIPPING
- RECEIVING
- NORTH
- SOUTH
- EAST
- WEST
- FRONT
- BACK
- SIDE

3. Scroll down to select **Save Settings**, and press ENTER:

SAVE SETTINGS

4. Turn power OFF with external disconnect as prompted:

SAVING  
SETTINGS...

---

SETUP COMPLETE  
TURN POWER OFF

## System Configuration (continued)

5. Wait 10 seconds, then turn system power ON with external disconnect.
6. System is now ready for use.

### Replace Existing Equipment

If existing equipment is being replaced with new equipment, serial numbers must be updated for each new piece of equipment as follows:

1. When installation is finished, turn system power ON with external disconnect.
2. Verify message on system Message Display (**A**):

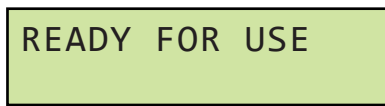

READY FOR USE

3. Press MENU (**B**) to enter the Main Menu. Scroll down to select **Settings** and press ENTER:

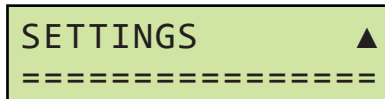

SETTINGS ▲  
=====

4. Scroll down to select **Program Access** and press ENTER:

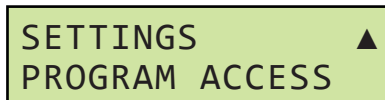

SETTINGS ▲  
PROGRAM ACCESS

5. Scroll down to select **Field Install** and press ENTER:

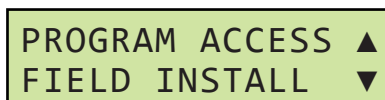

PROGRAM ACCESS ▲  
FIELD INSTALL ▼

6. Follow instructions for equipment on page 12 to input serial numbers as required.
7. After installation, maintenance and fault logs from old equipment can be cleared (recommended). Press ENTER or MENU as instructed:

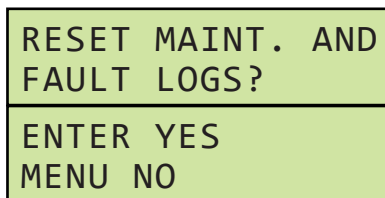

RESET MAINT. AND  
FAULT LOGS?  
ENTER YES  
MENU NO

(alternating messages)

8. Turn power OFF with external disconnect as prompted:

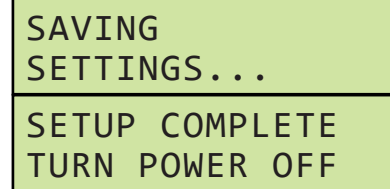

SAVING  
SETTINGS...  
SETUP COMPLETE  
TURN POWER OFF

9. Wait 10 seconds, then turn system power ON with external disconnect.
10. Verify changes in **System Info** menu (see page 20).
11. System is now ready for use.

# INSTALLATION

## System Settings

After the iDock Control System has been installed, it may be necessary to change system Settings to suit end user's specific needs.

To access the Settings menu:

1. Turn system power ON with external disconnect.
2. Press MENU to enter the Main Menu. Scroll down to select **Settings** and press ENTER:



**Note:** Maintenance Code will be required to access the Settings menu if code has been changed from default.

3. From the Settings menu, the following can be changed or adjusted. Press MENU button to exit or return to the previous menu:

- **User Language**
- **Change User Bypass Code**
- **Change Maintenance Code**
- **Timers (if applicable)**
- **Lights & Sound**
- **Date and Time (UTC time from factory)**
- **Network Connection**
- **Program Access**
- **Restraint Use**

### User Language

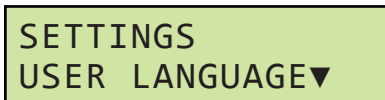

- To change the iDock Control System display language, press ENTER. Use the SCROLL UP/DOWN buttons to select desired language and ENTER button to confirm. The following languages are available:

- **English**
- **French**
- **Spanish**

### Change User Bypass Code

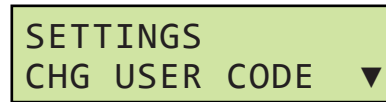

- To change the 3-digit User Code required to enter Bypass Mode, press ENTER. Use the SCROLL UP/DOWN buttons to change digit value and ENTER button to move to the next digit. Press MENU button to exit without saving changes:



- When the final digit has been selected, the new User Code will be saved.



**Note:** Setting User Code to 000 is the same as the factory default and no User Code will be required to activate Bypass Mode.

### Change Maintenance Code



- To change the 8-digit Maintenance Code required to enter the Maintenance menu, press ENTER. Use the SCROLL UP/DOWN buttons to change digit value and ENTER button to move to the next digit:



- When the final digit has been selected, the new User Code will be saved.



**Note:** When Maintenance Code is changed from default, new Maintenance Code will be required to access the Settings menu from that point on.

## System Settings (continued)

### Timers



- The Timers menu allows the user to adjust various system timing intervals and timeout periods to fine-tune operation. Do not adjust Timers unless instructed by Systems, LLC Technical Services:
  - **Hook Raise (Poweramp PowerHook restraint only)**
  - **Auto Store Extend (Poweramp PowerHook restraint only)**
  - **Auto Raise (Poweramp Hydraulic leveler w/PowerHook only)**
  - **Below Dock Raise (Hydraulic leveler only)**
  - **Below Dock Lip Out (Hydraulic leveler only)**
  - **Leveler Bump Back (VS/VSH only)**

**Note:** If an undesirable adjustment is made, reset to default timing by scrolling until DFLT appears on system Message Display:



### Lights & Sound

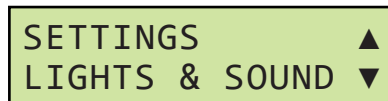

- The Lights & Sound menu allows the user to set the following:

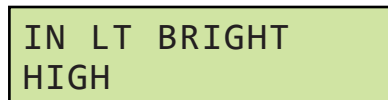

- **Inside Light Brightness** to change the intensity of the Multi-Colored LED Light.

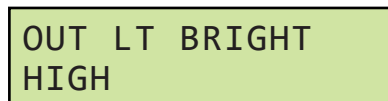

- **Outside Light Brightness** to change the intensity of the Outside Light Assembly.

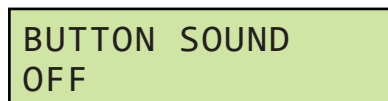

- **Button Sound** can be turned on/off to offer audible acknowledgment anytime a button is pressed.

### Date and Time

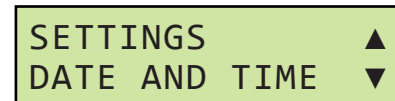

- The Date & Time menu allows the user to set the Date & Time for the iDock Control System:

- **Date** setting for the month, day and year:

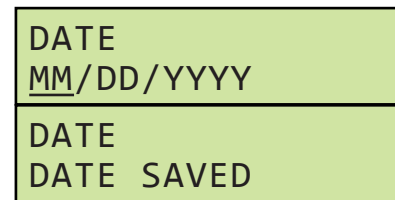

- **Time** setting for local time can be changed by selecting Time. The factory default setting is UTC time. Do not change the time setting from UTC if the iDock Control System will be used with iDock Connect!

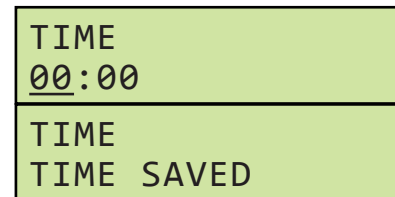

**Note:** iDock does not adjust for daylight savings time.

### Network Connection

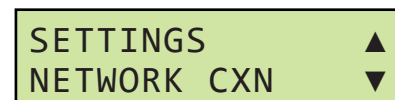

- The Network Connection menu allows the user to view the current status of the iDock Connect network connection, and to pair with or unpair from an iDock Connect gateway as needed:

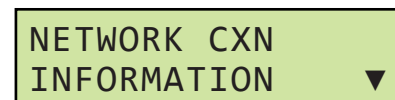

- **Information** allows the user to view the following information about the iDock Connect network connection:

- **Gateway Status**
- **Signal Strength**
- **Bond Status**
- **Gateway Address**
- **System Address**

# INSTALLATION

## System Settings (continued)

- **Module Version**

### Network Connection (continued)

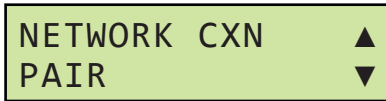

- **Pair** allows the user to pair the iDock Control System to a gateway for use with iDock Connect. To pair the iDock Control system with an iDock Connect gateway:

1. Obtain the Gateway Serial Number from the decal on the front of the gateway (see Figure 1).



Figure 1

2. On an internet-connected device, visit [www.idockconnect.com/pair](http://www.idockconnect.com/pair) and enter the gateway serial number in the **GATEWAY SERIAL NUMBER** field on the website (see Figure 2).

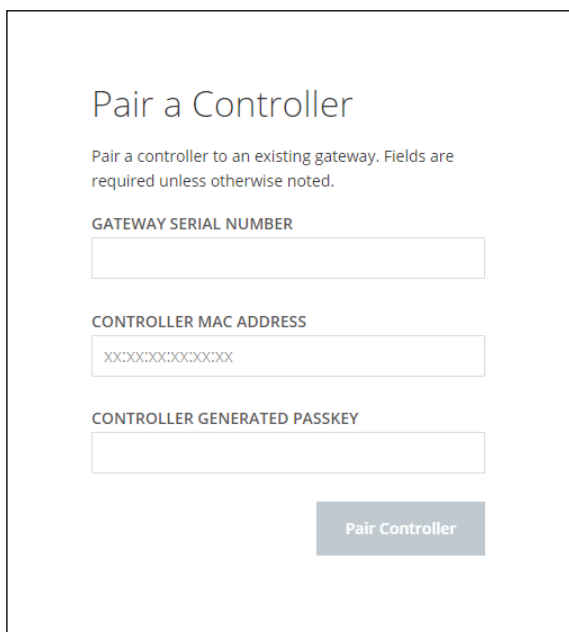

Figure 2

3. Obtain the Controller MAC Address and Controller Generated Passkey using the following steps:

- a. On the iDock controller, press MENU (**B**) to enter the **Main Menu**. Use the SCROLL UP/DOWN buttons (**D**) to scroll down to select **Settings** and press ENTER (**C**).



- b. In the **Settings** menu, scroll down to select **Network Connection** and press ENTER.

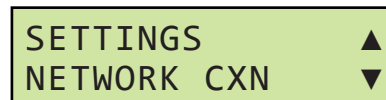

- c. In the **Network Connection** menu, **Information** is pre-selected. Press ENTER.

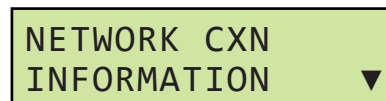

- d. In the **Information** menu, scroll down to **System Address**. Enter this address in the **CONTROLLER MAC ADDRESS** field on the website (see Figure 2).

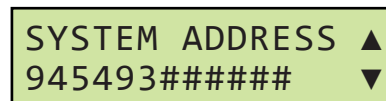

- e. When the Controller MAC Address has been obtained, press MENU once to exit the **Information** menu.

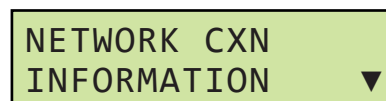

- f. In the **Network Connection** menu, scroll down to select **Pair** and press ENTER.

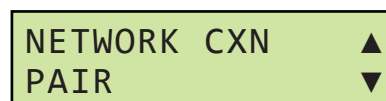

- g. Enter the generated code in the **CONTROLLER GENERATED PASSKEY** field on the website (see Figure 2).





## System Settings (continued)

- When all three fields on the website are filled, click **Pair Controller** on the website (see Figure 2).
- "Pairing Requested" message will appear on the website. The controller allows up to 60 seconds for pairing the gateway to the controller.

- If the pair is successful, **PAIRED SUCCESSFULLY** will appear on the controller Message Display and the controller will automatically exit the Pair screen. Once paired and connected, the Ready For Use screen will contain the BLE icon as shown below.

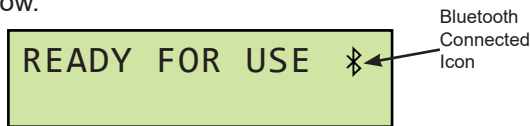

- If the gateway is successfully paired, but is not connected, the Bluetooth icon will appear as shown below. This could result if the gateway loses power or the signal is obstructed.

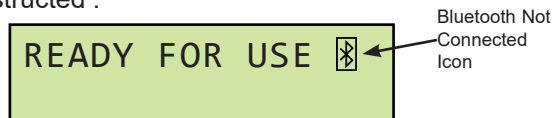

- If the pair is unsuccessful, the Pair screen on the controller Message Display will time out and exit. Pairing can be attempted again by repeating these instructions.

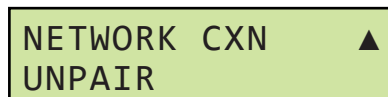

- Unpair** allows the user to unpair the iDock Control System from an iDock Connect gateway if needed.
- For more information on iDock Connect, refer to the iDock Connect User Guide.

### Program Access

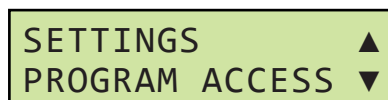

- The Program Access menu allows maintenance staff and/or service providers to complete base-level reconfiguration of the iDock Control System. This may be necessary if equipment is replaced and serial numbers need to be updated. Press ENTER button to enter Program Access menu:

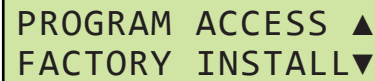

- Factory Install** allows for factory-level configuration of the iDock Control System. This menu is for internal use only.

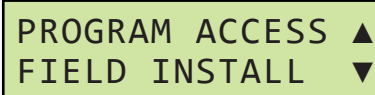

- Field Install** allows maintenance staff and/or service providers to update serial numbers if equipment is being replaced and clear fault logs for old equipment being removed. This menu is password-protected. See page 13 for more information.

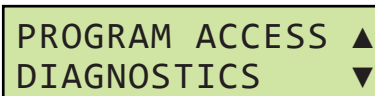

- Diagnostics** allows maintenance staff and/or service providers to view system-wide diagnostic information. See page 56 for more information.

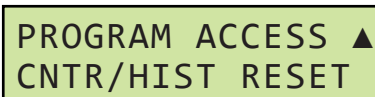

- Counter/History Reset** allows maintenance staff and/or service providers to reset all system-wide counters and fault history. This menu is password-protected. See page 54 for more information.

### Restraint Use



- The Restraint Use setting allows maintenance staff and/or service providers to enable or disable the vehicle restraint functions and allow independent usage of the dock leveler. Restraint Use should only be disabled in circumstances where the vehicle restraint cannot ever be used, such as the presence of a dumpster or other permanent object at the dock.
- Restraint Use must be set to ON for iDock Control Systems running Dock Alert/LCS setups with no vehicle restraint, or the lights will not change status correctly.

**Note:** If Restraint Use is disabled, the inside light will continuously flash Amber and the outside light will cease functioning.

# OPERATION

---

## Operational Precautions

### **DANGER**

Stay clear of dock leveler and vehicle restraint when transport vehicle is entering or leaving dock area.

DO NOT move or use the dock leveler or restraint if anyone is under or in front of the dock leveler.

Keep hands and feet clear of pinch points. Avoid putting any part of your body near moving parts.

### **WARNING**

Only trained personnel should operate the dock leveler and vehicle restraint.

DO NOT use a broken or damaged dock leveler or vehicle restraint. Make sure proper service and maintenance procedures have been performed on the equipment before operating.

Transport vehicle wheels must be chocked unless the vehicle restraint is used. Never remove the wheel chocks until loading/unloading is finished and transport vehicle driver has been given permission to leave.

Make sure platform lip rests on the transport vehicle bed with at least 4 in. (102 mm) of overlap.

Maintain a safe distance from side edges of leveler during the loading/unloading process.

### **WARNING**

Once the vehicle restraint has been activated, the dock attendant must visually inspect to assure that the restraint hook has properly engaged the Rear Impact Guard (RIG) bar.

## System Boot & User Code Entry

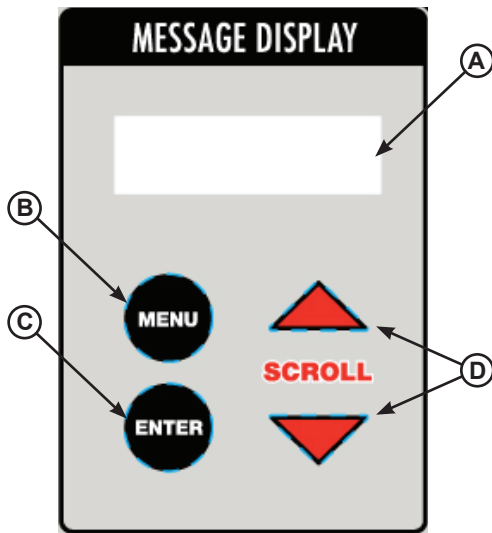

**System Control Buttons/Displays**  
**A** - Message Display  
**B** - MENU button  
**C** - ENTER button  
**D** - SCROLL UP/DOWN buttons

### System Boot

1. Turn system power ON with external disconnect.

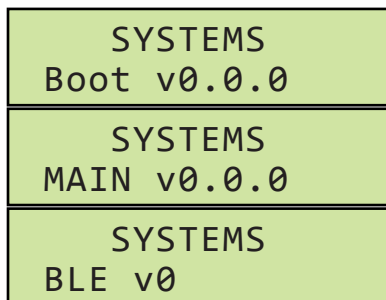

(alternating messages)

**Note:** (Versions referenced above will vary based on manufacturing date.)

2. Proceed to instructions for specific equipment on pages 22-49.

**Note:** If Message Display **(A)** also displays “MAINTENANCE DUE,” equipment may still be operated, but Planned Maintenance is due. See **PM Reset** on page 52 for instructions on resetting maintenance reminder.

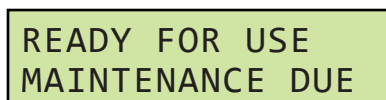

- If a fault is active, the message display will list the fault. See pages 62-69 for fault details and how to clear fault before operating equipment.
- If Message Display displays an error code beginning with the letter D, a LiftMaster® Maintenance Alert System (MAS)-capable Logic 5.0 commercial door operator is experiencing a fault. See page 70 for MAS codes:

D1 DOOR CONTROL SERVICE IS DUE

### Enter User Code

**Note:** Bypass Mode may require a User Code for access. The User Code is defined in the Settings Menu during initial setup.

No code is default from factory. Owner/user is responsible to define 3-digit code if required; this code can be added or changed at any time.

1. Verify user code prompt on system Message Display:

ENTER USER CODE  
000

2. Use the SCROLL UP/DOWN buttons **(D)** to change digit value and ENTER button **(C)** to move to the next digit until the three-digit user code is entered.
3. Locked function can now be used.

**Note:** User Code access may be restricted. Contact a supervisor if system User Code is unknown

# OPERATION

---

## Main Menu

When equipment is not in use, various functions can be accessed from the iDock Control System main menu. The user can see equipment information, change basic settings, and more.

To access the Main Menu:

1. Press MENU button (**B**). User is now in the Main Menu. The following functions are available:
  - **Operating Mode**
  - **Equipment Info**
  - **System Info**
  - **Counters**
  - **Maintenance**
  - **Settings**

**Note:** Once Main Menu is active, both the inside and outside lights will change to solid red with no flashing.

## Operating Mode

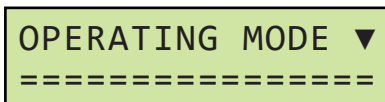

- **Restraint Only and Leveler/Restraint models:** Allows user to select the following operating modes:
  - **Normal**
  - **Bypass**
  - **Lights On/ Off**

See Operating Instructions for specific equipment on pages 22-49 for more information.

## Equipment Info

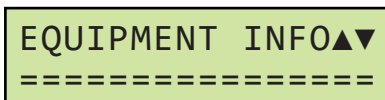

- Allows the user to view the following data (if applicable):
  - **Controller Serial Number**
  - **Restraint Serial Number**
  - **Restraint Install Date**
  - **Leveler Serial Number**
  - **Leveler Install Date**
  - **Door Number**
  - **Door Position**

**Note:** This information is presented in a read-only view. See Installation on pages 12-13 for instructions on inputting/changing this information.

## System Info

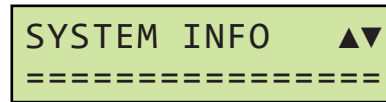

- Allows the user to view the following system configuration data (if applicable):
  - **Brand Name**
  - **Restraint Model**
  - **Leveler Model**
  - **Door Buttons**
  - **Interlocks**
  - **Dock Light**
  - **Expansion Board**
  - **CentraPower**
  - **Leveler Stored Indicator**

**Note:** This information is presented in a read-only view. These settings are determined by the factory. If any setting does not correspond to the equipment being used, contact Systems, LLC Technical Services.

See page 62 for more information on interlocking options.

## Counters

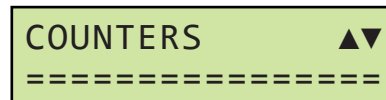

- Allows the user to view the following system counters (if applicable):
  - **Next PM Date**
  - **Logged PM's**
  - **Restraint Engage Cycles**
  - **Restraint Release Cycles**
  - **Restraint Bypass Cycles**
  - **Missed ICC**
  - **Leveler Cycles**
  - **Door Control Codes**
  - **Vehicle Present**
  - **Fork Lift**
  - **Door Cycles**
  - **Missed ICC Bar**

## Main Menu (continued)

### Maintenance

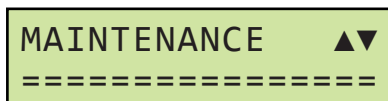

- Allows maintenance staff and/or service providers to log maintenance and access detailed fault information:
  - **Fault History**
  - **Door Code Counters**
  - **Door Code History**
  - **Maintenance Entry**
  - **Maintenance Records**

**Note:** Access to this menu may require a Maintenance Code. For more information, see **Maintenance** on pages 50-55:

### Settings



- Allows the user to change various system settings (if applicable):
  - **User Language**
  - **Change User Code**
  - **Change Maintenance Code**
  - **Timers**
  - **Lights & Sound**
  - **Date and Time**
  - **Network CXN**
  - **Program Access**
  - **Restraint Use**

# OPERATION

## Operating Instructions - Dock Alert/LCS

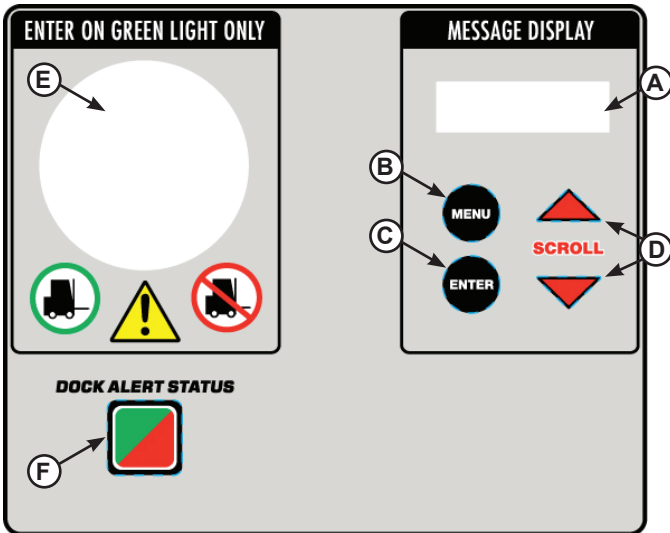

- |                                     |                                 |
|-------------------------------------|---------------------------------|
| System Control Buttons/<br>Displays | Equipment Control Buttons       |
| A - Message Display                 | F - DOCK ALERT STATUS<br>button |
| B - MENU button                     |                                 |
| C - ENTER button                    |                                 |
| D - SCROLL UP/DOWN buttons          |                                 |
| E - Multi-Colored LED Light         |                                 |

### Dock Alert/LCS - Manual Operated Lights

1. Verify messages on system Message Display (A).

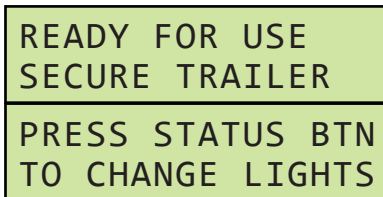

(alternating messages)

2. Press DOCK ALERT STATUS button (F) to change lights to notify driver of loading/unloading:

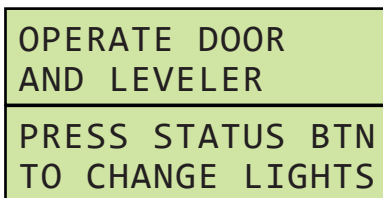

(alternating messages)

3. Open the overhead door, and check to make sure transport vehicle is positioned squarely against both dock bumpers.
4. Chock the transport vehicle wheels, or use the vehicle restraint (if available).
5. Use the dock leveler (if available) to complete loading and/or unloading the transport vehicle.

6. When loading and/or unloading is finished, remove chocks from transport vehicle wheels or release the vehicle restraint (if available).
7. Press DOCK ALERT STATUS button to change lights to notify driver it is safe to depart.

### Dock Alert/LCS - Door Operated Lights

1. Verify messages on system Message Display:

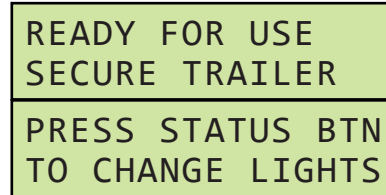

(alternating messages)

2. Open overhead door to change lights to notify driver of loading/unloading.
3. Check to make sure transport vehicle is positioned squarely against both dock bumpers.
4. Chock the transport vehicle wheels, or use the vehicle restraint (if available).
5. Use the dock leveler (if available) to complete loading and/or unloading the transport vehicle.
6. When loading and/or unloading is finished, remove chocks from transport vehicle wheels or release the vehicle restraint (if available).
7. Close overhead door to change lights to notify driver it is safe to depart.

## Operating Instructions - Dock Alert/LCS (continued)

### Dock Alert /LCS- Leveler Operated Lights

1. Verify messages on system Message Display:

READY FOR USE  
SECURE TRAILER

OPEN DOOR BEFORE  
USE OF LEVELER

POSITION LEVELER  
TO CHANGE LIGHTS

(alternating messages)

2. Open the overhead door, and check to make sure transport vehicle is positioned squarely against both dock bumpers.
3. Chock the transport vehicle wheels, or use the vehicle restraint (if available).
4. Use the dock leveler to complete loading and/or unloading the transport vehicle. Lights will change when leveler leaves stored position and system Message Display will show the following.

POSITION LEVELER  
TO CHANGE LIGHTS

5. When loading and/or unloading is finished, remove chocks from transport vehicle wheels or release the vehicle restraint (if available).
6. Store the dock leveler to change lights to notify driver it is safe to depart.

### Dock Alert/LCS - Bypass Mode

**Note:** Dock Alert models with Door or Leveler Operated Lights have the ability to manually override the lights in Bypass Mode.

Bypass Mode may require a User Code for access.

1. Press the DOCK ALERT STATUS button and Verify messages on system Message Display: Message will vary depending on equipment.

### Door Operated Light models:

OPEN DOOR  
OR

PRESS ENTER  
FOR BYPASS MODE

(alternating messages)

### Leveler Operated Light models:

OPERATE LEVELER  
OR

PRESS ENTER  
FOR BYPASS MODE

(alternating messages)

2. Press the ENTER button (C) to enter Bypass Mode and change lights to notify driver of loading/unloading. Verify message on system Message Display:

PRESS STATUS BTN  
TO RESET LIGHTS

### **Note:**

3. When use of Bypass Mode is complete, press the DOCK ALERT STATUS button to return the lights to normal operation. Verify message on system Message Display:

LIGHTS RESET TO  
NORMAL MODE

### Dock Alert/LCS - Turn Lights Off

**Note:** Users have the ability to turn off lights completely if desired.

1. Press and hold the DOCK ALERT STATUS button for at least 3 seconds. Message Display will show:

TURN LIGHTS OFF  
▼▼▼▼

2. The marks at the bottom will count up to the full width of the Message Display and the lights will turn off. Verify message on system Message Display:

READY FOR USE  
SECURE TRAILER

DOCK ALERT  
LIGHTS ARE OFF

PRESS STATUS BTN  
2 TURN LIGHTS ON

(alternating messages)

3. To turn the lights back on, press the DOCK ALERT STATUS button.



# OPERATION

## Operating Instructions - Dock Alert/LCS w/Pit or HED Leveler

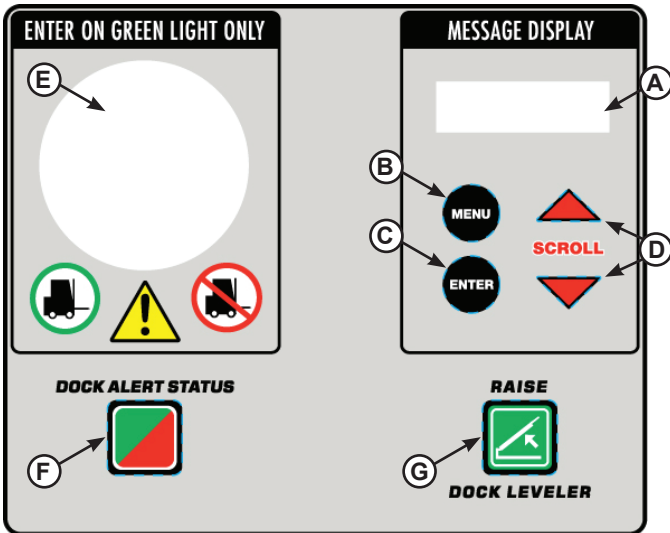

- |   |   |
|---|---|
| <p><b>System Control Buttons/ Displays</b></p> <p>A - Message Display</p> <p>B - MENU button</p> <p>C - ENTER button</p> <p>D - SCROLL UP/DOWN buttons</p> <p>E - Multi-Colored LED Light</p> | <p><b>Equipment Control Buttons</b></p> <p>F - DOCK ALERT STATUS button</p> <p>G - RAISE button</p> |
|---|---|

6. Press and hold the RAISE button (G) until lip extends, then release button and allow leveler to descend into transport vehicle.
7. Complete loading and/or unloading of transport vehicle. Verify message on system Message Display:

STORE LEVELER  
WHEN COMPLETE

---

PRESS STATUS BTN  
TO CHANGE LIGHTS

(alternating messages)

8. When loading and/or unloading is finished, store dock leveler by pressing the RAISE button until leveler clears transport vehicle, and remove chocks from transport vehicle wheels or release the vehicle restraint (if available).
9. Press DOCK ALERT STATUS button to change lights to notify driver it is safe to depart.

### Pit or HED Leveler - Manual Operated Lights

1. Verify messages on system Message Display (A).

READY FOR USE  
SECURE TRAILER

---

PRESS STATUS BTN  
TO CHANGE LIGHTS

(alternating messages)

2. Press DOCK ALERT STATUS button (F) to change lights to notify driver of loading/unloading. Verify messages on system Message Display:

OPERATE DOOR  
AND LEVELER

---

PRESS STATUS BTN  
TO CHANGE LIGHTS

(alternating messages)

3. Open the overhead door, and check to make sure transport vehicle is positioned squarely against both dock bumpers.
4. Chock the transport vehicle wheels, or use the vehicle restraint (if available).
- 5.

## Operating Instructions - Dock Alert/LCS w/Pit or HED Leveler (continued)

### Pit or HED Leveler - Door Operated Lights

1. Verify messages on system Message Display:

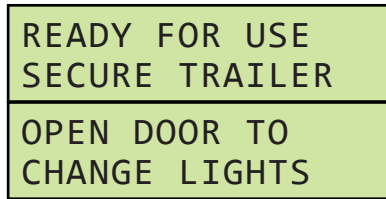

(alternating messages)

2. Open overhead door to change lights to notify driver of loading/unloading. Verify messages on system Message Display:

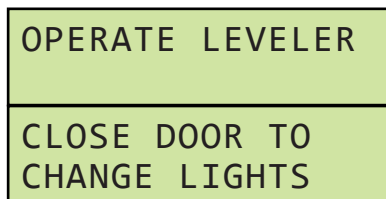

(alternating messages)

3. Check to make sure transport vehicle is positioned squarely against both dock bumpers.
4. Chock the transport vehicle wheels, or use the vehicle restraint (if available).
5. Press and hold the RAISE button until lip extends, then release button and allow leveler to descend into transport vehicle.
6. Complete loading and/or unloading of transport vehicle. Verify message on system Message Display:

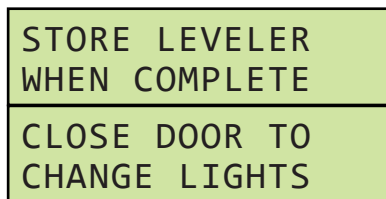

(alternating messages)

7. When loading and/or unloading is finished, store dock leveler by pressing the RAISE button until leveler clears transport vehicle, and remove chocks from transport vehicle wheels or release the vehicle restraint (if available).
8. Close overhead door to change lights to notify driver it is safe to depart.

### Pit or HED Leveler - Leveler Operated Lights

1. Verify messages on system Message Display:

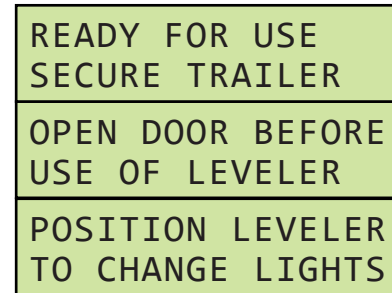

(alternating messages)

2. Open the overhead door, and check to make sure transport vehicle is positioned squarely against both dock bumpers.
3. Chock the transport vehicle wheels, or use the vehicle restraint (if available).
4. Press and hold the RAISE button until lip extends, then release button and allow leveler to descend into transport vehicle.
5. Complete loading and/or unloading of transport vehicle. Verify message on system Message Display:

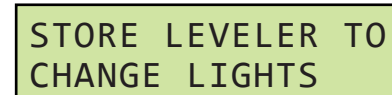

6. When loading and/or unloading is finished, remove chocks from transport vehicle wheels or release the vehicle restraint (if available).
7. Store the dock leveler to change lights to notify driver it is safe to depart.

# OPERATION

---

## Operating Instructions - Dock Alert/LCS w/Pit or HED Leveler (continued)

### Pit or HED Leveler - Bypass Mode

**Note:** Pit or HED Levelers with Door or Leveler Operated Lights have the ability to manually override the lights in Bypass Mode.

Bypass Mode may require a User Code for access.

1. Press the DOCK ALERT STATUS button and verify messages on system Message Display. Message will vary depending on equipment:

#### Door Operated Light models:

OPEN DOOR OR
PRESS ENTER FOR BYPASS MODE

(alternating messages)

#### Leveler Operated Light models:

OPERATE LEVELER OR
PRESS ENTER FOR BYPASS MODE

(alternating messages)

2. Press the ENTER button (C) to enter Bypass Mode and change lights to notify driver of loading/unloading. Verify message on system Message Display:

PRESS STATUS BTN TO RESET LIGHTS
-------------------------------------

3. When use of Bypass Mode is complete, press the DOCK ALERT STATUS button to return the lights to normal operation. Verify message on system Message Display:

LIGHTS RESET TO NORMAL MODE
--------------------------------

### Pit or HED Leveler - Turn Lights Off

**Note:** Users have the ability to turn off lights completely if desired.

1. Press and hold the DOCK ALERT STATUS button for at least 3 seconds. Message Display will show:

TURN LIGHTS OFF ▼▼▼▼▼
--------------------------

2. The marks at the bottom will count up to the full width of the Message Display and the lights will turn off. Verify message on system Message Display:

READY FOR USE SECURE TRAILER
DOCK ALERT LIGHTS ARE OFF
PRESS STATUS BTN 2 TURN LIGHTS ON

(alternating messages)

3. To turn the lights back on, press the DOCK ALERT STATUS button.

**This page intentionally left blank.**

# OPERATION

## Operating Instructions - Dock Alert/LCS w/Pit Leveler and Lip Out

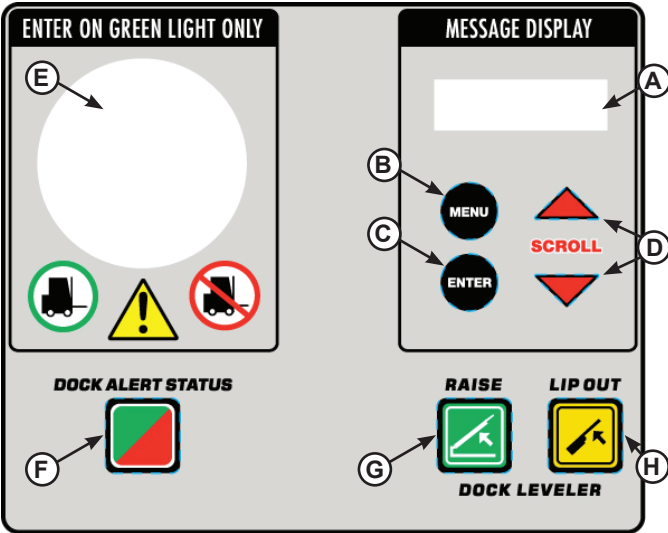

- |                                     |                                 |
|-------------------------------------|---------------------------------|
| System Control Buttons/<br>Displays | Equipment Control Buttons       |
| A - Message Display                 | F - DOCK ALERT STATUS<br>button |
| B - MENU button                     | G - RAISE button                |
| C - ENTER button                    | H - LIP OUT button              |
| D - SCROLL UP/DOWN buttons          |                                 |
| E - Multi-Colored LED Light         |                                 |

**Note:** Pit Levelers with Quick Cycle Lip Extend (Lip Out) function identically to regular Pit Levelers, except that the leveler lip can be independently extended before the platform is fully raised. See pages 24-26 for general Pit Leveler operating instructions.

When equipped with a Leveler Stored (LS) proximity switch, Pit Leveler iDock Control Systems with Lip Out can also perform a Quick-Cycle Below Dock End Load function.

### Pit Leveler- Quick Cycle Lip Extend (Lip Out)

1. Follow operating instructions on pages 24-26 until leveler use is required.
2. Press and hold the RAISE button (**G**). After the leveler lip is above the transport vehicle, press and hold the LIP OUT button (**H**) in addition to the RAISE button.
3. When lip has fully extended, release the RAISE and LIP OUT buttons. Leveler will descend into transport vehicle with lip fully extended.
4. Continue with operating instructions on pages 24-26 as needed.

### Pit Leveler- Quick Cycle Below Dock End Load

1. Follow operating instructions on pages 24-26 until below-dock leveler use is required.
2. Press and hold the LIP OUT button. Message Display will show:

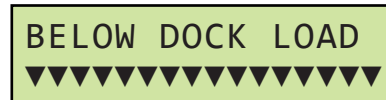

3. The marks at the bottom will count down to zero and the leveler will briefly raise, slightly extend the lip to clear the lip keepers, and then descend below dock.
4. Below dock end loading/unloading can now be completed. Continue with operating instructions on pages 24-26 as needed.

**Note:** If LIP OUT button is released before Below Dock Load countdown finishes, iDock Control System will return to the previous state.

**This page intentionally left blank.**

# OPERATION

## Operating Instructions - Dock Alert/LCS w/Vertical Leveler

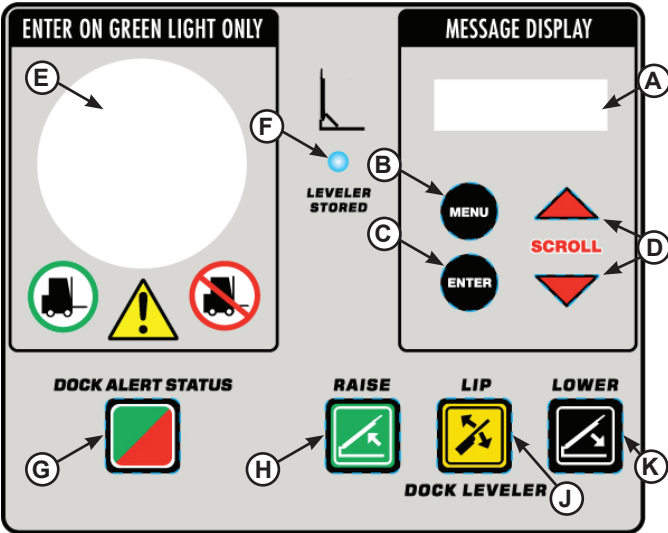

- |                                     |                                 |
|-------------------------------------|---------------------------------|
| System Control Buttons/<br>Displays | Equipment Control Buttons       |
| A - Message Display                 | G - DOCK ALERT STATUS<br>button |
| B - MENU button                     | H - RAISE button                |
| C - ENTER button                    | J - LIP button                  |
| D - SCROLL UP/DOWN buttons          | K - LOWER button                |
| E - Multi-Colored LED Light         |                                 |
| F - Leveler Stored Light            |                                 |

### Vertical Leveler - Manual Operated Lights

1. Verify messages on system Message Display (A).

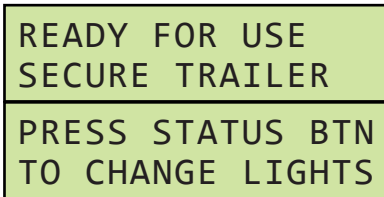

(alternating messages)

2. Press DOCK ALERT STATUS button (G) to change lights to notify driver of loading/unloading. Verify messages on system Message Display:

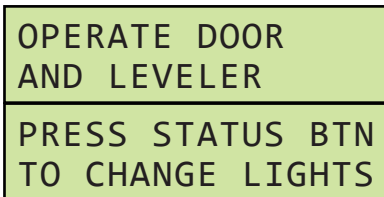

(alternating messages)

3. Open the overhead door, and check to make sure transport vehicle is positioned squarely against both dock bumpers.
4. Chock the transport vehicle wheels, or use the vehicle restraint (if available).

5. Press and hold the LOWER button until leveler reaches float zone, then allow leveler to descend into transport vehicle. Verify message on system Message Display

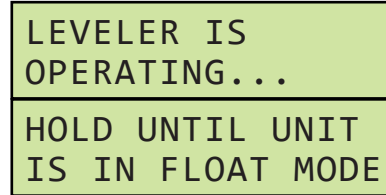

(alternating messages)

- Note:** If lip position needs to be adjusted before reaching float zone, see Lip Operation on page 33.

- Complete loading and/or unloading of transport vehicle. Verify message on system Message Display:

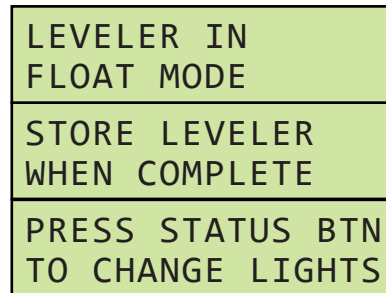

(alternating messages)

6. When loading and/or unloading is finished, press and hold the RAISE button (H) until the blue Leveler Stored Light (F) turns on. Verify message on system Message Display:

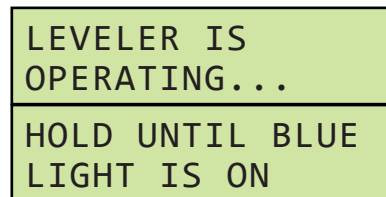

(alternating messages)

7. Remove chocks from transport vehicle wheels or release the vehicle restraint (if available).
8. Press DOCK ALERT STATUS button to change lights to notify driver it is safe to depart.



## Operating Instructions - Dock Alert/LCS w/Vertical Leveler (continued)

### Vertical Leveler - Door Operated Lights

1. Verify messages on system Message Display:

READY FOR USE SECURE TRAILER
OPEN DOOR TO CHANGE LIGHTS

(alternating messages)

2. Open overhead door to change lights to notify driver of loading/unloading. Verify messages on system Message Display:

OPERATE LEVELER
CLOSE DOOR TO CHANGE LIGHTS

(alternating messages)

3. Check to make sure transport vehicle is positioned squarely against both dock bumpers.
4. Chock the transport vehicle wheels, or use the vehicle restraint (if available).
5. Press and hold the LOWER button until leveler reaches float zone, then allow leveler to descend into transport vehicle. Verify message on system Message Display:

LEVELER IS OPERATING...
HOLD UNTIL UNIT IS IN FLOAT MODE

(alternating messages)

**Note:** If lip position needs to be adjusted before reaching float zone, see Lip Operation on page 33.

6. Complete loading and/or unloading of transport vehicle. Verify message on system Message Display:

LEVELER IN FLOAT MODE
STORE LEVELER WHEN COMPLETE
CLOSE DOOR TO CHANGE LIGHTS

(alternating messages)

7. When loading and/or unloading is finished, press and hold the RAISE button until the blue Leveler Stored Light turns on. Verify message on system Message Display:

LEVELER IS OPERATING...
HOLD UNTIL BLUE LIGHT IS ON

(alternating messages)

8. Close overhead door to change lights to notify driver it is safe to depart. Verify message on system Message Display:

LEVELER STORED CLOSE DOOR
CLOSE DOOR TO CHANGE LIGHTS

(alternating messages)

# OPERATION

## Operating Instructions - Dock Alert/LCS w/Vertical Leveler (continued)

### Vertical Leveler - Leveler Operated Lights

1. Verify messages on system Message Display:

READY FOR USE SECURE TRAILER
OPEN DOOR BEFORE USE OF LEVELER
POSITION LEVELER TO CHANGE LIGHTS

(alternating messages)

2. Open the overhead door, and check to make sure transport vehicle is positioned squarely against both dock bumpers.
3. Chock the transport vehicle wheels, or use the vehicle restraint (if available).
4. Press and hold the LOWER button until leveler reaches float zone, then allow leveler to descend into transport vehicle. Verify message on system Message Display:

LEVELER IS OPERATING...
HOLD UNTIL UNIT IS IN FLOAT MODE

(alternating messages)

**Note:** If lip position needs to be adjusted before reaching float zone, see Lip Operation on page 33.

5. Complete loading and/or unloading of transport vehicle. Verify message on system Message Display:

LEVELER IN FLOAT MODE
STORE LEVELER WHEN COMPLETE
STORE LEVELER TO CHANGE LIGHTS

(alternating messages)

6. When loading and/or unloading is finished, remove chocks from transport vehicle wheels or release the vehicle restraint (if available).

7. Press and hold the RAISE button until the blue Leveler Stored Light turns on. Verify message on system Message Display:

LEVELER IS OPERATING...
HOLD UNTIL BLUE LIGHT IS ON

(alternating messages)

8. Store the dock leveler to change lights to notify driver it is safe to depart.

### Vertical Leveler - Bypass Mode

**Note:** Vertical Levelers with Door or Leveler Operated Lights have the ability to manually override the lights in Bypass Mode.

Bypass Mode may require a User Code for access.

1. Press the DOCK ALERT STATUS button and verify messages on system Message Display. Message will vary depending on equipment:

#### Door Operated Light models:

OPEN DOOR OR
PRESS ENTER FOR BYPASS MODE

(alternating messages)

#### Leveler Operated Light models:

OPERATE LEVELER OR
PRESS ENTER FOR BYPASS MODE

(alternating messages)

2. Press the ENTER button (C) to enter Bypass Mode and change lights to notify driver of loading/unloading. Verify message on system Message Display:

PRESS STATUS BTN TO RESET LIGHTS
-------------------------------------

## Operating Instructions - Dock Alert/LCS w/Vertical Leveler (continued)

- When use of Bypass Mode is complete, press the DOCK ALERT STATUS button to return the lights to normal operation. Verify message on system Message Display:

LIGHTS RESET TO  
NORMAL MODE

### Vertical Leveler - Turn Lights Off

**Note:** Users have the ability to turn off lights completely if desired.

- Press and hold the DOCK ALERT STATUS button for at least 3 seconds. Message Display will show:

TURN LIGHTS OFF  
▼▼▼▼

- The marks at the bottom will count up to the full width of the Message Display and the lights will turn off. Verify message on system Message Display:

READY FOR USE  
SECURE TRAILER  
DOCK ALERT  
LIGHTS ARE OFF  
PRESS STATUS BTN  
2 TURN LIGHTS ON

(alternating messages)

- To turn the lights back on, Press the DOCK ALERT STATUS button.

### Vertical Leveler- Lip Operation

**Note:** Vertical Levelers are equipped with LIP button (J). This allows the leveler lip to be independently raised and lowered as needed when the leveler is between stored and float zones.

- Follow operating instructions on pages 30-32 until lip positioning is required.
- Press and hold the LOWER button to move the leveler out of the stored position. Then, press and hold the LIP button in addition to the RAISE or LOWER button as needed. While lip is moving, Message Display will show:

LEVELER IS  
OPERATING...

- When lip has reached desired position, release the LIP and LOWER or RAISE buttons.
- Continue with operating instructions on pages 30-32 as needed.

# OPERATION

## Operating Instructions - Vehicle Restraint

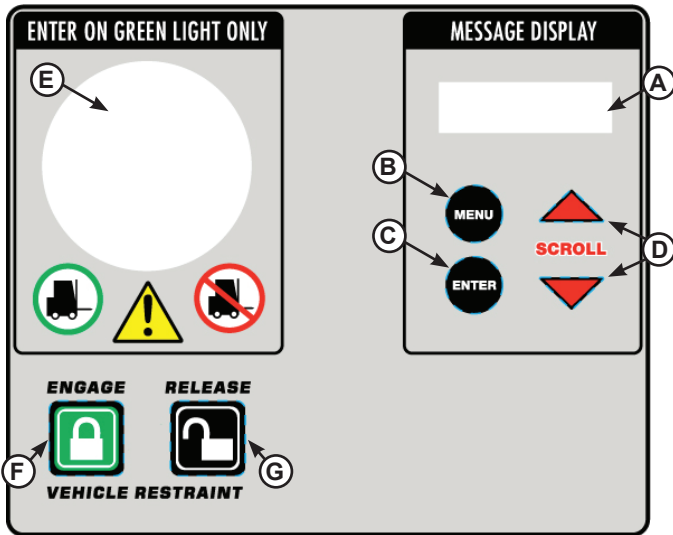

- System Control Buttons/  
Displays
- Equipment Control Buttons
- A - Message Display
  - B - MENU button
  - C - ENTER button
  - D - SCROLL UP/DOWN buttons
  - E - Multi-Colored LED Light
  - F - ENGAGE button
  - G - RELEASE button

### Vehicle Restraint - Engage & Release

1. Open overhead door and check to make sure transport vehicle is positioned squarely against both dock bumpers.
2. Press ENGAGE button (F) to initiate restraint engage cycle. Outside lights will change to notify driver of loading/unloading.
3. When vehicle restraint has successfully engaged, inside lights will change.
4. Visually confirm that restraint has successfully captured RIG bar. If capture is not possible, see instructions for "Missed RIG & Bypass Mode."
5. Use the dock leveler (if available) to complete loading and/or unloading the transport vehicle.
6. When loading and/or unloading is finished, store dock leveler (if available).

7. Press RELEASE button (G) to change inside lights and initiate restraint release cycle. While restraint is operating, verify messages on system Message Display (A):

RELEASING  
RESTRAINT . . .

8. When vehicle restraint has successfully released, outside lights will change to notify driver it is safe to depart. Verify message on system Message Display:

### Auto Re-Engage (TPR, TPR UniLock & Stop AAL Restraints Only)

After restraint has been engaged with successful capture of RIG bar, these restraints will automatically attempt to re-engage if they leave the working zone:

#### TPR/UniLock

- When restraint hook is rotated below the working zone, the controls will automatically attempt to re-engage the hook one (1) time.
  - If hook successfully captures the RIG bar again, the light communication will remain the same.
  - If hook is unable to return to the working zone after one (1) attempt, the hook will automatically return to the stored position, and the iDock Control System will alert the operator that the restraint is no longer engaged with a Bypass Mode prompt. See "Bypass Mode (after auto-store).

#### Stop-AAL

- When restraint hook is lowered to the stored position without pressing the RELEASE button, the controls will automatically attempt to re-engage the hook one (1) time.
  - If hook successfully captures the RIG bar again, the light communication will remain the same.
  - If hook is unable to return to the working zone after one (1) attempt, the hook will automatically return to the stored position, and the iDock Control System will alert the operator that the restraint is no longer engaged with a Bypass Mode prompt. See "Bypass Mode (after auto-store).

## Operating Instructions - Vehicle Restraint (continued)

### Vehicle Restraint - Bypass Mode (after auto-store)

**Note:** If vehicle restraint cannot successfully engage the transport vehicle due to a damaged/missing RIG bar, lift gate obstruction, or any other reason, the restraint will automatically return to the stored position. Users have the ability to manually override the lights in Bypass Mode.

Bypass Mode may require a User Code for access.

1. Complete steps 1-5 in "Vehicle Restraint - Engage & Release" on page 34.
2. When vehicle restraint fails to engage RIG bar, restraint will automatically return to stored position. Verify message on system Message Display:

NOT ENGAGED
RETURNING TO STORED POSITION

(alternating messages)

3. After restraint has stored, system Message Display will give user the option to override lights and proceed without vehicle restraint in **Bypass Mode** by pressing ENTER (C). To reset the system press RELEASE.

PRESS ENTER FOR BYPASS MODE
PRESS RELEASE TO RESET LIGHTS

(alternating messages)

4. Secure transport vehicle wheels by other means as directed by Message Display:

SECURE TRAILER BY OTHER MEANS
OPERATE DOOR AND LEVELER
PRESS RELEASE TO RESET LIGHTS

(alternating messages)

5. Use the dock leveler (if available) to complete loading and/or unloading the transport vehicle.
6. When loading and/or unloading is finished, release transport vehicle wheels.
7. Press RELEASE button to exit Bypass Mode and change lights to notify driver it is safe to depart. Verify message on system Message Display:

LIGHTS RESET TO NORMAL MODE
-----------------------------

### Vehicle Restraint - Bypass Mode (Main Menu)

**Note:** Users can also directly enter Bypass Mode through the Main Menu.

Bypass Mode may require a User Code for access.

1. Press the MENU button (B). User is now in the Main Menu. Select Operating Mode by pressing ENTER button:

OPERATING MODE ▼
=====

**Note:** Once Main Menu is active, both the inside and outside lights will change to solid red with no flashing.

2. Press ENTER button to initiate the mode change, then use the SCROLL DOWN button (D) to change from NORMAL to BYPASS, and press ENTER again to activate Bypass Mode:

OPERATING MODE BYPASS
-----------------------

3. Verify message on system Message Display:

SECURE TRAILER BY OTHER MEANS
OPERATE DOOR AND LEVELER
PRESS RELEASE TO RESET LIGHTS

(alternating messages)

4. Use the dock leveler (if available) to complete loading and/or unloading the transport vehicle.

# OPERATION

---

## Operating Instructions - Vehicle Restraint

### Vehicle Restraint - Bypass Mode (Main Menu, continued)

- When loading and/or unloading is finished, release transport vehicle wheels.
- Press RELEASE button to exit Bypass Mode and change lights to notify driver it is safe to depart. Verify message on system Message Display:

LIGHTS RESET TO  
NORMAL MODE

### Vehicle Restraint - Bypass Mode (with optional Door Close to Reset Lights)

**Note:** iDock Control Systems can also be configured to reset the lights from Bypass Mode by closing the overhead door.

- Follow steps on pages 34-35 to enter Bypass Mode after auto-store or through the Main Menu.
- Verify message on system Message Display:

SECURE TRAILER  
BY OTHER MEANS

OPERATE DOOR  
AND LEVELER

PRESS RELEASE  
TO RESET LIGHTS

CLOSE DOOR  
TO RESET LIGHTS

(alternating messages)

- Use the dock leveler (if available) to complete loading and/or unloading the transport vehicle.
- When loading and/or unloading is finished, release transport vehicle wheels.
- Either close the overhead door, or press RELEASE button to exit Bypass Mode and change lights to notify driver it is safe to depart. Verify message on system Message Display:

LIGHTS RESET TO  
NORMAL MODE

### Emergency Stop (All Restraints)

If equipped with optional Emergency Stop and E-Stop is activated, once deactivated, the inside lights will flash Red/Amber.

- If restraint is in the stored position, press the RELEASE button.
- If restraint is in the engaged button, press the ENGAGE button.

### Power Interruption (PowerHook and TPR restraints only)

If power to the control box is interrupted, the inside light will flash Red/Amber and the outside light will flash Red. The restraint must then be cycled to teach its position.

RESTRAINT  
POSITION UNKNOWN

PRESS ENGAGE  
OR RELEASE

- If restraint is in the stored position, press the RELEASE button.
- If restraint is in the engaged position, press the ENGAGE button.
- If the restraint is in the stored position and the iDock was in Bypass Mode before the power interruption, the operator must confirm the transport vehicle is secured by another means. Then select Bypass Mode again using the Operating Mode menu.

**This page intentionally left blank.**

# OPERATION

## Operating Instructions - Pit or HED Leveler w/Vehicle Restraint

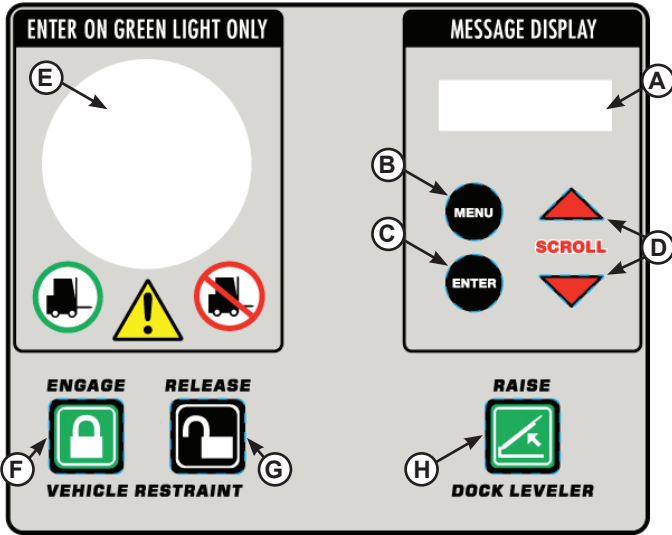

- |   |  |
|---|--|
| <p><b>System Control Buttons/ Displays</b></p> <p>A - Message Display<br/>         B - MENU button<br/>         C - ENTER button<br/>         D - SCROLL UP/DOWN buttons<br/>         E - Multi-Colored LED Light</p> | <p><b>Equipment Control Buttons</b></p> <p>F - ENGAGE button<br/>         G - RELEASE button<br/>         H - RAISE button</p> |
|---|--|

### Pit or HED Leveler w/Vehicle Restraint

1. Open overhead door and check to make sure transport vehicle is positioned squarely against both dock bumpers.
2. Press ENGAGE button (F) to initiate restraint engage cycle. Outside lights will change to notify driver of loading/unloading.
3. When vehicle restraint has successfully engaged, inside lights will change.
4. Visually confirm that restraint has successfully captured RIG bar. If capture is not possible, see instructions for "Missed RIG & Bypass Mode."
5. Press and hold the RAISE button (H) until lip extends, then release button and allow leveler to descend into transport vehicle

6. Complete loading and/or unloading of transport vehicle. Verify message on system Message Display (A):

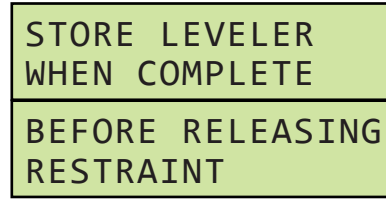

(alternating messages)

7. When loading and/or unloading is finished, store dock leveler by pressing the RAISE button (H) until leveler clears transport vehicle, and press RELEASE button (G) to change inside lights and initiate restraint release cycle. While restraint is operating, verify message on system Message Display:

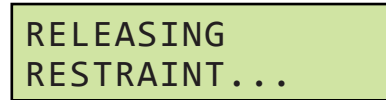

8. When vehicle restraint has successfully released, outside lights will change to notify driver it is safe to depart.

### Auto Re-Engage (TPR, TPR UniLock & Stop AAL Restraints Only)

After restraint has been engaged with successful capture of RIG bar, these restraints will automatically attempt to re-engage if they leave the working zone:

#### TPR/UniLock

- When restraint hook is rotated below the working zone, the controls will automatically attempt to re-engage the hook one (1) time.
  - If hook successfully captures the RIG bar again, the light communication will remain the same.
  - If hook is unable to return to the working zone after one (1) attempt, the hook will automatically return to the stored position, and the iDock Control System will alert the operator that the restraint is no longer engaged with a Bypass Mode prompt. See "Bypass Mode (after auto-store).



## Operating Instructions - Pit or HED Leveler w/Vehicle Restraint (continued)

### Stop-AAL

- When restraint hook is lowered to the stored position without pressing the RELEASE button, the controls will automatically attempt to re-engage the hook one (1) time.
  - If hook successfully captures the RIG bar again, the light communication will remain the same.
  - If hook is unable to return to the working zone after one (1) attempt, the hook will automatically return to the stored position, and the iDock Control System will alert the operator that the restraint is no longer engaged with a Bypass Mode prompt. See "Bypass Mode (after auto-store).

### Pit or HED Leveler w/Vehicle Restraint - Bypass Mode (after auto-store)

**Note:** If vehicle restraint cannot successfully engage the transport vehicle due to a damaged/missing RIG bar, lift gate obstruction, or any other reason, the restraint will automatically return to the stored position. Users have the ability to manually override the lights in Bypass Mode.

Bypass Mode may require a User Code for access.

- Complete steps 1-5 in "Pit or HED Leveler w/ Vehicle Restraint" on page 38.
- When vehicle restraint fails to engage RIG bar, restraint will automatically return to stored position. Verify message on system Message Display:

NOT ENGAGED
RETURNING TO STORED POSITION

(alternating messages)

- After restraint has stored, system Message Display will give user the option to override lights and proceed without vehicle restraint in **Bypass Mode** by pressing ENTER (C). To reset the system press RELEASE.

PRESS ENTER FOR BYPASS MODE
PRESS RELEASE TO RESET LIGHTS

(alternating messages)

- Secure transport vehicle wheels by other means as directed by Message Display:

SECURE TRAILER BY OTHER MEANS
OPERATE DOOR AND LEVELER
STORE LEVELER WHEN COMPLETE
PRESS RELEASE TO RESET LIGHTS

(alternating messages)

- Press and hold the RAISE button until lip extends, then release button and allow leveler to descend into transport vehicle.
- Complete loading and/or unloading of transport vehicle. Verify message on system Message Display:

SECURE TRAILER BY OTHER MEANS
OPERATE DOOR AND LEVELER
STORE LEVELER WHEN COMPLETE
PRESS RELEASE TO RESET LIGHTS

(alternating messages)

- When loading and/or unloading is finished, press RAISE button to store dock leveler and release transport vehicle wheels.

# OPERATION

## Operating Instructions - Pit or HED Leveler w/Vehicle Restraint

### Pit or HED Leveler w/Vehicle Restraint - Bypass Mode (after auto-store, continued)

8. Press RELEASE button to exit Bypass Mode, change lights to notify driver it is safe to depart. Verify message on system Message Display:

LIGHTS RESET TO  
NORMAL MODE

### Pit or HED Leveler w/Vehicle Restraint - Bypass Mode (Main Menu)

**Note:** Users can also directly enter Bypass Mode through the Main Menu.

Bypass Mode may require a User Code for access.

1. Press the MENU button (B). User is now in the Main Menu. Select Operating Mode by pressing ENTER button:

OPERATING MODE ▼  
=====

**Note:** Once Main Menu is active, both the inside and outside lights will change to solid red with no flashing.

2. Press ENTER button to initiate the mode change, then use the SCROLL DOWN button (D) to change from NORMAL to BYPASS, and press ENTER again to activate Bypass Mode:

OPERATING MODE  
BYPASS

3. Verify message on system Message Display:

SECURE TRAILER  
BY OTHER MEANS  
OPERATE DOOR  
AND LEVELER  
PRESS RELEASE  
TO RESET LIGHTS

(alternating messages)

4. Press and hold the RAISE button until lip extends, then release button and allow leveler to descend into transport vehicle.

5. Complete loading and/or unloading of transport vehicle. Verify message on system Message Display:

SECURE TRAILER  
BY OTHER MEANS  
OPERATE DOOR  
AND LEVELER  
STORE LEVELER  
WHEN COMPLETE  
PRESS RELEASE  
TO RESET LIGHTS

(alternating messages)

6. When loading and/or unloading is finished, press RAISE button to store dock leveler and release transport vehicle wheels.
7. Press RELEASE button to exit Bypass Mode, change lights to notify driver it is safe to depart. Verify message on system Message Display:

LIGHTS RESET TO  
NORMAL MODE

### Pit or HED Leveler w/Vehicle Restraint - Bypass Mode (with optional Door Close to Reset Lights)

**Note:** iDock Control Systems can also be configured to reset the lights from Bypass Mode by closing the overhead door.

1. Follow steps on pages 39-40 to enter Bypass Mode after auto-store or through the Main Menu.
2. Verify message on system Message Display:

SECURE TRAILER  
BY OTHER MEANS  
OPERATE DOOR  
AND LEVELER  
PRESS RELEASE  
TO RESET LIGHTS  
CLOSE DOOR  
TO RESET LIGHTS

(alternating messages)

3. Press and hold the RAISE button until lip extends, then release button and allow leveler to descend into transport vehicle.
4. Complete loading and/or unloading of transport vehicle.
5. When loading and/or unloading is finished, store dock leveler and release transport vehicle wheels.
6. Either close the overhead door, or press RELEASE button to exit Bypass Mode and change lights to notify driver it is safe to depart. Verify message on system Message Display:

LIGHTS RESET TO  
NORMAL MODE

### **Emergency Stop (All Restraints)**

If equipped with optional Emergency Stop and E-Stop is activated, once deactivated, the inside lights will flash Red/Amber.

- If restraint is in the stored position, press the RELEASE button.
- If restraint is in the engaged position, press the ENGAGE button.

### **Power Interruption (Poweramp PowerHook Restraints Only)**

If power to the control box is interrupted, the inside light will flash Red/Amber and the outside light will flash Red. The restraint must then be cycled to determine its position.

RESTRAINT  
POSITION UNKNOWN  
PRESS ENGAGE  
OR RELEASE

- If restraint is in the stored position, press the RELEASE button.
- If restraint is in the engaged position, press the ENGAGE button.
- If the restraint is in the stored position and the iDock was in Bypass Mode before the power interruption, the operator must confirm the transport vehicle is secured by another means. Then select Bypass Mode again using the Operating Mode menu.

# OPERATION

## Operating Instructions - Pit Leveler w/Lip Out and Vehicle Restraint

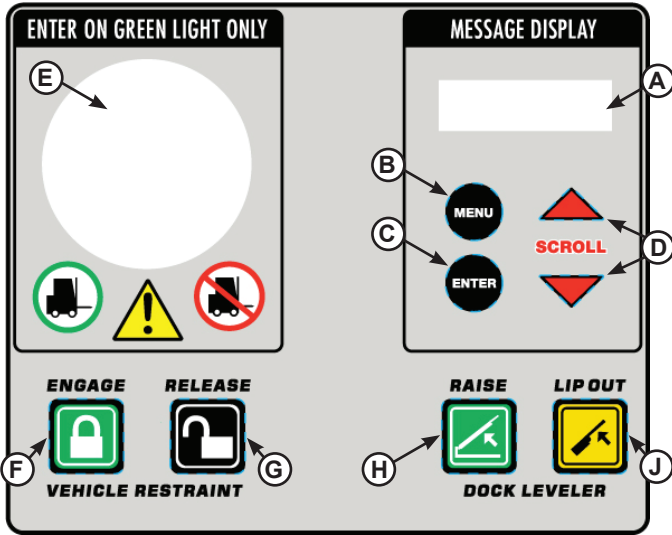

- |                                     |                           |
|-------------------------------------|---------------------------|
| System Control Buttons/<br>Displays | Equipment Control Buttons |
| A - Message Display                 | F - ENGAGE button         |
| B - MENU button                     | G - RELEASE button        |
| C - ENTER button                    | H - RAISE button          |
| D - SCROLL UP/DOWN buttons          | J - LIP OUT button        |
| E - Multi-Colored LED Light         |                           |

**Note:** Pit Levelers with Quick Cycle Lip Extend (Lip Out) and Vehicle Restraints function identically to regular Pit Levelers with Vehicle Restraints, except that the leveler lip can be independently extended before the platform is fully raised. See pages 38-41 for general Pit Leveler & Vehicle Restraint operating instructions.

When equipped with a Leveler Stored (LS) proximity switch, Pit Leveler iDock Control Systems with Lip Out can also perform a Quick-Cycle Below Dock End Load function.

### Pit Leveler- Quick Cycle Lip Extend (Lip Out)

1. Follow operating instructions on pages 38-41 until leveler use is required.
2. Press and hold the RAISE button (G). After the leveler lip is above the transport vehicle, press and hold the LIP OUT button (H) in addition to the RAISE button.
3. When lip has fully extended, release the RAISE and LIP OUT buttons. Leveler will descend into transport vehicle with lip fully extended.
4. Continue with operating instructions on pages 38-41 as needed.

### Pit Leveler- Quick Cycle Below Dock End Load

1. Follow operating instructions on pages 38-41 until below-dock leveler use is required.
2. Press and hold the LIP OUT button. Message Display will show:

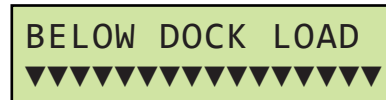

3. The marks at the bottom will count down to zero and the leveler will briefly raise, slightly extend the lip to clear the lip keepers, and then descend below dock.
4. Below dock end loading/unloading can now be completed. Continue with operating instructions on pages 38-41 as needed.

**Note:** If LIP OUT button is released before Below Dock Load countdown finishes, iDock Control System will return to the previous state.

**This page intentionally left blank.**

# OPERATION

## Operating Instructions - Vertical Leveler w/Vehicle Restraint

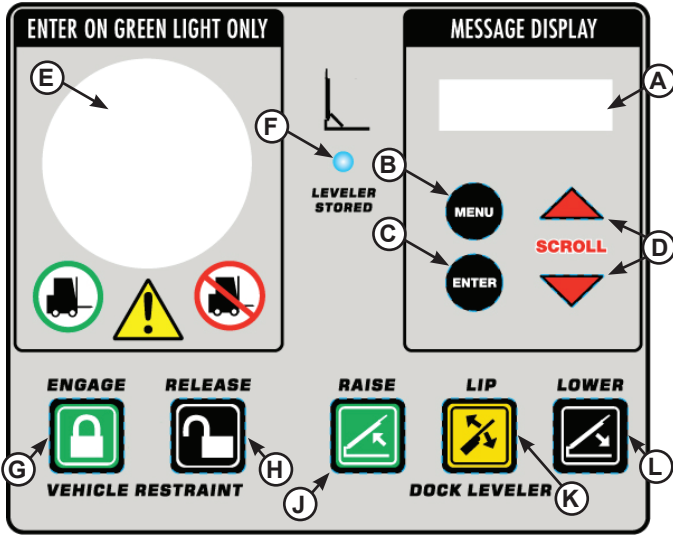

- | System Control Buttons/<br>Displays | Equipment Control Buttons |
|-------------------------------------|---------------------------|
| A - Message Display                 | G - ENGAGE button         |
| B - MENU button                     | H - RELEASE button        |
| C - ENTER button                    | J - RAISE button          |
| D - SCROLL UP/DOWN buttons          | K - LIP button            |
| E - Multi-Colored LED Light         | L - LOWER button          |
| F - Leveler Stored Light            |                           |

### Vertical Leveler w/Vehicle Restraint

1. Verify messages on system Message Display (A).

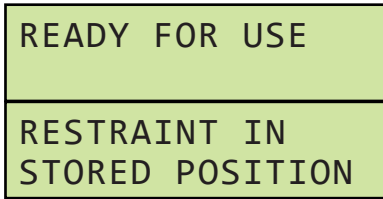

(alternating messages)

2. Open overhead door and check to make sure transport vehicle is positioned squarely against both dock bumpers.
3. Press ENGAGE button (G) to initiate restraint engage cycle. Outside lights will change to notify driver of loading/unloading.

4. When vehicle restraint has successfully engaged, inside lights will change. Verify messages on Message Display.

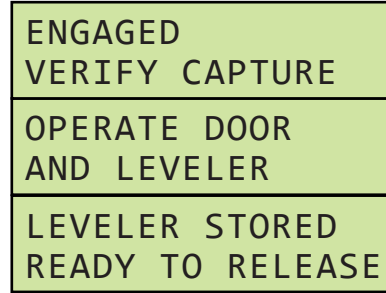

(alternating messages)

5. Visually confirm that restraint has successfully captured RIG bar. If capture is not possible, see instructions for "Bypass Mode."
6. Press and hold the LOWER button (L) until leveler reaches float zone, then allow leveler to descend into transport vehicle. Verify message on system Message Display:

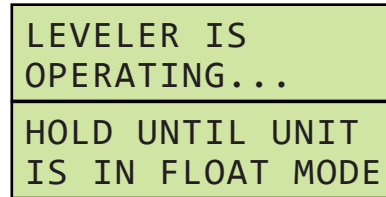

(alternating messages)

**Note:** If lip position needs to be adjusted before reaching float zone, see Lip Operation on page 47.

7. Complete loading and/or unloading of transport vehicle. Verify message on system Message Display:

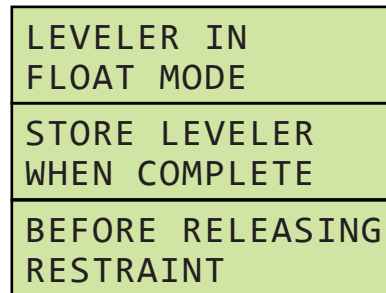

(alternating messages)

## Operating Instructions - Vertical Leveler w/Vehicle Restraint (continued)

- When loading and/or unloading is finished, press and hold the RAISE button (J) until the blue Leveler Stored Light (F) turns on. Verify message on system Message Display:

LEVELER IS  
OPERATING...  
HOLD UNTIL BLUE  
LIGHT IS ON

(alternating messages)

- Press RELEASE button (H) to change inside lights and initiate restraint release cycle. While restraint is operating, verify message on system Message Display:

RELEASING  
RESTRAINT...

- When vehicle restraint has successfully released, outside lights will change to notify driver it is safe to depart. Verify message on system Message Display:

RESTRAINT IN  
STORED POSITION

### Auto Re-Engage (TPR, TPR UniLock & Stop AAL Restraints Only)

After restraint has been engaged with successful capture of RIG bar, these restraints will automatically attempt to re-engage if they leave the working zone:

#### TPR/UniLock

- When restraint hook is rotated below the working zone, the controls will automatically attempt to re-engage the hook one (1) time.
  - If hook successfully captures the RIG bar again, the light communication will remain the same.
  - If hook is unable to return to the working zone after one (1) attempt, the hook will automatically return to the stored position, and the iDock Control System will alert the operator that the restraint is no longer engaged with a Bypass Mode prompt. See "Bypass Mode (after auto-store).

#### Stop-AAL

- When restraint hook is lowered to the stored position without pressing the RELEASE button, the controls will automatically attempt to re-engage the hook one (1) time.
  - If hook successfully captures the RIG bar again, the light communication will remain the same.
  - If hook is unable to return to the working zone after one (1) attempt, the hook will automatically return to the stored position, and the iDock Control System will alert the operator that the restraint is no longer engaged with a Bypass Mode prompt. See "Bypass Mode (after auto-store).

### Vertical Leveler w/Vehicle Restraint - Bypass Mode (after auto-store)

**Note:** If vehicle restraint cannot successfully engage the transport vehicle due to a damaged/missing RIG bar, lift gate obstruction, or any other reason, the restraint will automatically return to the stored position. Users have the ability to manually override the lights in Bypass Mode.

- Complete steps 1-5 in "Vertical Leveler w/Vehicle Restraint" on page 44.
- When vehicle restraint fails to engage RIG bar, restraint will return to stored position. Verify message on system Message Display:

NOT ENGAGED  
RETURNING TO  
STORED POSITION

(alternating messages)

- After restraint has stored, system Message Display will give user the option to override lights and proceed without vehicle restraint in **Bypass Mode** by pressing ENTER (C). To reset the system press RELEASE.

PRESS ENTER  
FOR BYPASS MODE  
PRESS RELEASE  
TO RESET LIGHTS

(alternating messages)

# OPERATION

## Operating Instructions - Vertical Leveler w/Vehicle Restraint (continued)

### Vertical Leveler w/Vehicle Restraint - Bypass Mode (after auto-store, continued)

- Secure transport vehicle wheels by other means as directed by Message Display:

SECURE TRAILER BY OTHER MEANS
OPERATE DOOR AND LEVELER
LEVELER STORED READY TO RELEASE
PRESS RELEASE TO RESET LIGHTS

(alternating messages)

- Press and hold the LOWER button until leveler reaches float zone, then allow leveler to descend into transport vehicle. Verify message on system Message Display:

LEVELER IS OPERATING...
HOLD UNTIL UNIT IS IN FLOAT MODE

(alternating messages)

**Note:** If lip position needs to be adjusted before reaching float zone, see Lip Operation on page 46.

- Complete loading and/or unloading of transport vehicle. Verify message on system Message Display:

LEVELER IN FLOAT MODE
STORE LEVELER WHEN COMPLETE
PRESS RELEASE TO RESET LIGHTS

(alternating messages)

- When loading and/or unloading is finished, press and hold the RAISE button until the blue Leveler Stored Light turns on. Verify message on system Message Display:

LEVELER IS OPERATING...
HOLD UNTIL BLUE LIGHT IS ON

(alternating messages)

- Release transport vehicle wheels.
- Press RELEASE button to exit Bypass Mode, change lights to notify driver it is safe to depart. Verify message on system Message Display:

LIGHTS RESET TO NORMAL MODE
--------------------------------

### Vertical Leveler w/Vehicle Restraint - Bypass Mode (through Main Menu)

**Note:** Users can also directly enter Bypass Mode through the Main Menu.

Bypass Mode may require a User Code for access.

- Press the MENU button (**B**). User is now in the Main Menu. Select Operating Mode by pressing ENTER button:

OPERATING MODE ▼ =====
---------------------------

**Note:** Once Main Menu is active, both the inside and outside lights will change to solid red with no flashing.

- Press ENTER button to initiate the mode change, then use the SCROLL DOWN button (**D**) to change from NORMAL to BYPASS, and press ENTER again to activate Bypass Mode:

OPERATING MODE BYPASS
--------------------------



3. Verify message on system Message Display:

SECURE TRAILER BY OTHER MEANS
OPERATE DOOR AND LEVELER
PRESS RELEASE TO RESET LIGHTS

(alternating messages)

4. When use of Bypass Mode is complete, press RELEASE button to exit Bypass Mode, change lights to notify driver it is safe to depart. Verify message on system Message Display:

LIGHTS RESET TO NORMAL MODE
--------------------------------

### Vertical Leveler- Lip Operation

**Note:** Vertical Levelers are equipped with LIP button (K). This allows the leveler lip to be independently raised and lowered as needed when the leveler is between stored and float zones.

1. Follow operating instructions on pages 44-46 until lip positioning is required.
2. Press and hold the LOWER button to move the leveler out of the stored position. Then, press and hold the LIP button in addition to the RAISE or LOWER button as needed. While lip is moving, Message Display will show:

LEVELER IS OPERATING...
----------------------------

3. When lip has reached desired position, release the LIP and LOWER or RAISE buttons.
4. Continue with operating instructions on pages 44-47 as needed.

### Emergency Stop (All Restraints)

If equipped with optional Emergency Stop and E-Stop is activated, once deactivated, the inside lights will flash Red/Amber.

- If restraint is in the stored position, press the RELEASE button.
- If restraint is in the engaged button, press the ENGAGE button.

### Power Interruption (Poweramp PowerHook Restraints Only)

If power to the control box is interrupted, the inside light will flash Red/Amber and the outside light will flash Red. The restraint must then be cycled to determine its position.

RESTRAINT POSITION UNKNOWN
PRESS ENGAGE OR RELEASE

- If restraint is in the stored position, press the RELEASE button.
- If restraint is in the engaged position, press the ENGAGE button.
- If the restraint is in the stored position and the iDock was in Bypass Mode before the power interruption, the operator must confirm the transport vehicle is secured by another means. Then select Bypass Mode again using the Operating Mode menu.

# OPERATION

## Operating Instructions - Optional Equipment

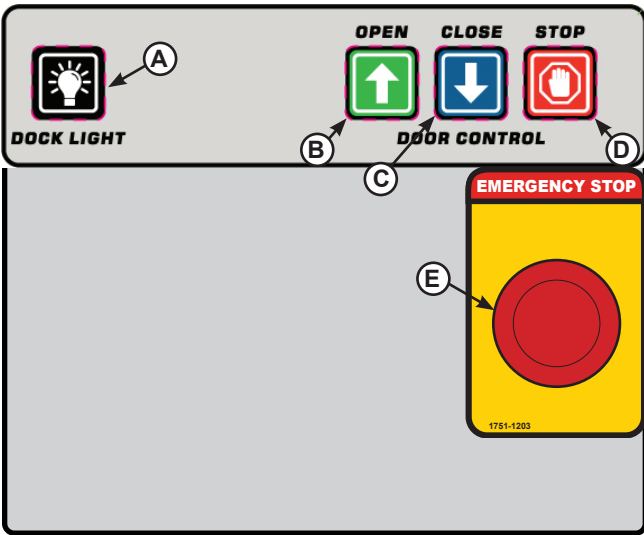

- Equipment Control Buttons
- A - DOCK LIGHT Button
  - B - OPEN Button
  - C - CLOSE Button
  - D - STOP Button
  - E - EMERGENCY STOP Button

### Overhead Door Controls

**Note:** iDock Control Systems are available with optional integrated Overhead Door controls. These door controls can be interlocked with a transport vehicle restraint or dock leveler as necessary. Due to the large number of possible interlock combinations and sequences, these instructions provide a general overview of door operation.

1. Verify message on system Message Display.

OPERATE DOOR  
AND LEVELER

2. Press door OPEN button (B). While overhead door is operating, Message Display will show:

DOOR BUTTON  
IS PRESSED

3. When the overhead door is fully open, operate other equipment and complete loading/unloading as required. Door can also be stopped while in motion by pressing door STOP button (D).

4. When loading/unloading is complete, store other equipment as required. Press door CLOSE button (C). While overhead door is operating, Message Display will show:

DOOR BUTTON  
IS PRESSED

5. When the overhead door is fully closed, proceed to operate other equipment as required.

### Emergency Stop (E-Stop)

**Note:** For iDock Control Systems equipped with optional Emergency Stop (E-Stop), all functions controlled by the iDock Control System can be halted in place by using the EMERGENCY STOP button:

1. While operating the iDock Control System, press the EMERGENCY STOP button (E).
2. iDock equipment being operated will halt in place, and Message Display will show:

E - STOP ACTIVE

**Note:** Once EMERGENCY STOP is active, both the inside and outside lights will change to solid red with no flashing.

No equipment will be operational and MENU buttons will not function while EMERGENCY STOP is active.

3. When hazard has been cleared or system must be operated, pull the EMERGENCY STOP button outward.

### WARNING

When Emergency Stop is active, DO NOT go under the dock leveler, walk or drive on the dock leveler, or leave forklift and/or material sitting on the leveler!

If Emergency Stop button is pressed with the dock leveler unsupported in the working zone, the leveler will descend when E-Stop is released!

Always support the dock leveler by external means if it is necessary to go under the dock leveler.

4. Continue operating dock equipment as needed.

## Operating Instructions - Optional Equipment (continued)

### Emergency Stop (All Restraints)

If equipped with optional Emergency Stop and E-Stop is activated, once deactivated, the inside lights will flash Red/Amber.

- If restraint is in the stored position, press the RELEASE button.
- If restraint is in the engaged position, press the ENGAGE button.



### Dock Light

**Note:** iDock Control Systems equipped with optional Dock Lights provide a multi-use, articulating light assembly that can be switched on and off from the iDock Control Panel.

### Dock Light - Operating Modes

- **On/Off**

1. Press the DOCK LIGHT button (A) to turn the Dock Light on. Position the Dock Light as needed.
2. When use is complete, press the DOCK LIGHT button again to turn the Dock Light off.

- **On/Off/Auto w/door (optional feature)**

**Note:** Feature requires door switch interlocking.

1. Open the overhead door. Dock Light will automatically turn on. Position the Dock Light as needed.
2. When use is complete, close the overhead door. Dock Light will automatically turn off.

- **On/Off/Auto w/leveler (optional feature)**

**Note:** Feature requires leveler stored switch interlocking.

1. Operate the dock leveler. When the leveler leaves the stored position, Dock Light will automatically turn on. Position the Dock Light as needed.
2. When use is complete, return the dock leveler to the stored position. Dock Light will automatically turn off.

# Operating Instructions - Communication Lights

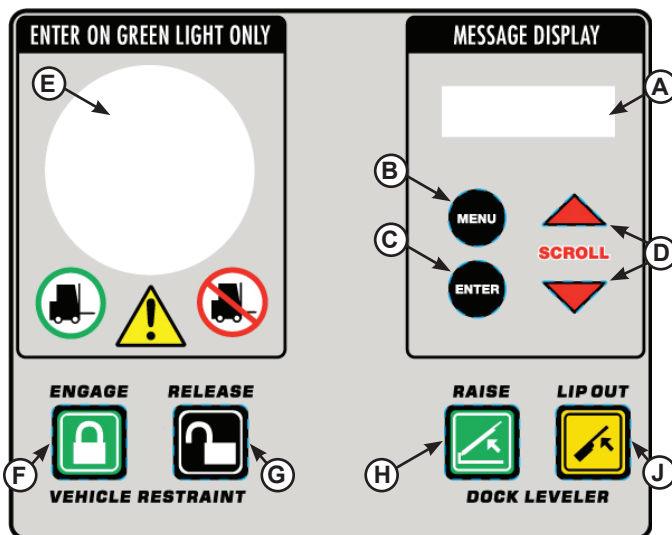

- | System Control Buttons/<br>Displays |  | Equipment Control Buttons  |  |
|-------------------------------------|--|----------------------------|--|
| A - Message Display                 |  | F - ENGAGE button          |  |
| B - MENU button                     |  | G - RELEASE button         |  |
| C - ENTER button                    |  | H - RAISE button           |  |
| D - SCROLL UP/DOWN buttons          |  | J - LIP OUT button         |  |
| E - Multi-Colored LED Light         |  | K - Outside Light Assembly |  |

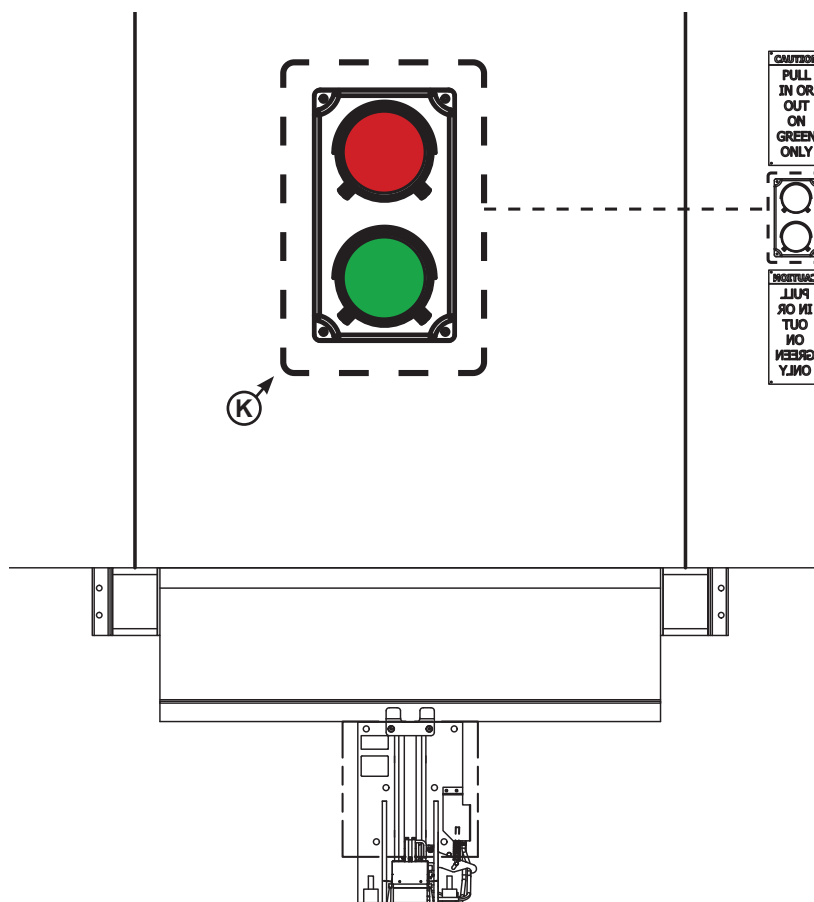

---

### **Operating Mode**

1. Press the MENU button (**B**). User is now in the Main Menu. Select Operating Mode by pressing ENTER button:

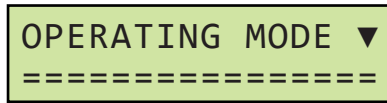

**Note:** Once Main Menu is active, both the inside and outside lights will change to solid red with no flashing.

- **Restraint Only and Leveler/Restraint models:**  
Allows user to select the following operating modes, using the scroll arrows:
  - **Normal**
  - **Bypass**
  - **Lights On/ Off**

### **Turn Lights Off:**

1. With "Lights On" selected, press enter. This will turn off the Multicolored LED (**E**), Outside Light (**K**) and optional Edge Lights (Not Shown).

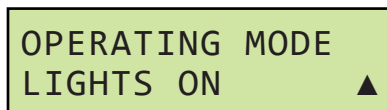

- The display will change to below:

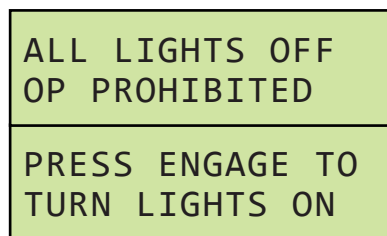

**Note:** Equipment operation is prohibited until lights are turned on again.

2. Press the release button to reset the lights and return to Normal Operating Mode.

### **Turn Lights On:** (Without using Release Button)

1. Press the MENU button (**B**). User is now in the Main Menu. Select Operating Mode by pressing ENTER button:

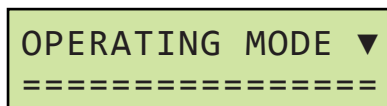

2. Then use the scroll arrows to select "Lights Off" and press enter.



3. This will turn on the Multicolor LED (**E**), Outside light assembly (**K**) and Edge Lights, if equipped. The equipment will return to the previous operating mode and change the communication lights according to the equipment position.

See Operating Instructions for specific equipment on previous pages 22-49 for more information.

# MAINTENANCE

## Maintenance

From the Maintenance menu, maintenance staff and/or service providers have the ability to log maintenance and access detailed fault information.

To access the Maintenance menu:

1. Press the MENU button (B). User is now in the Main Menu. Use the SCROLL UP/DOWN buttons (D) and press ENTER button (C) to select Maintenance:

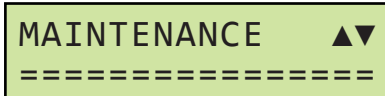

**Note:** If required, Maintenance Code will need to be entered at this time.

2. The following functions can be selected. Press MENU button to exit or return to the previous menu at any time:

- Fault History
- Door Code Counters
- Door Code History
- Maintenance Entry
- Maintenance Records

### Fault History



- The Fault History menu displays a list of iDock Control System faults that have occurred, along with the date and time of occurrence, from most recent to least recent. Press ENTER button to see Fault History:

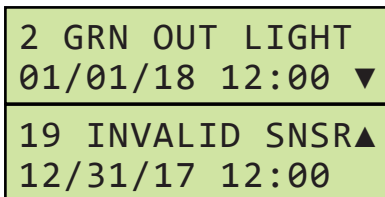

- The Fault History menu displays the 50 most recent faults that have occurred. See "Fault Codes" on pages 62-69 for detailed fault information. Use the SCROLL UP/DOWN buttons to see when each fault has occurred. When finished, press the MENU button to return to the Maintenance menu.

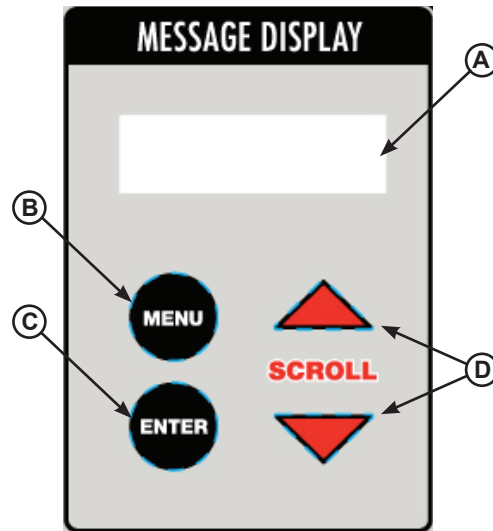

System Control Buttons/Displays

- A - Message Display
- B - MENU button
- C - ENTER button
- D - SCROLL UP/DOWN buttons

### Door Code Counters

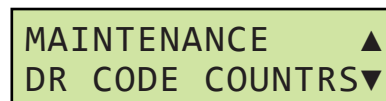

- When a LiftMaster® Maintenance Alert System (MAS)-capable Logic 5.0 commercial door operator is interfaced with the iDock Control System, the Door Code Counters menu displays a list of all door operator codes that have occurred, along with the number of times that each code has occurred since the system was configured. Press ENTER button to see Door Code Counters:

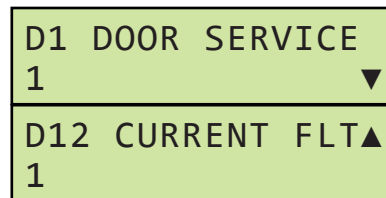

- There are numerous LiftMaster® Maintenance Alert System faults. See "LiftMaster® MAS Codes" on page 70 for detailed fault information. Use the SCROLL UP/DOWN buttons to see the number of times each code has occurred. When finished, press the MENU button to return to the Maintenance menu.

## Maintenance (continued)

### Door Code History

```
MAINTENANCE ▲
DR CODE HISTORY ▼
```

- When a LiftMaster® Maintenance Alert System (MAS)-capable Logic 5.0 commercial door operator is interfaced with the iDock Control System, the Door Code History menu displays a list of door operator codes that have occurred, along with the date and time of occurrence, from most recent to least recent. Press ENTER button to see Door Code Counters:

```
D1 DOOR SERVICE
01/01/18 12:00 ▼
D12 CURRENT FLT▲
12/31/17 12:00
```

- The Door Code History menu displays the 50 most recent door operator faults that have occurred. See “LiftMaster® MAS Codes” on page 70 for detailed code information. Use the SCROLL UP/DOWN buttons to see when each code has occurred. When finished, press the MENU button to return to the Maintenance menu.

### Maintenance Entry

```
MAINTENANCE ▲
MAINT ENTRY ▼
```

- The Maintenance Entry menu allows maintenance staff and/or service providers to log maintenance and/or part replacements anytime work is performed. Press ENTER button to access the following functions:

```
MAINT ENTRY
RESTRAINT ▼
```

- Restraint Maintenance** can be selected to log general maintenance, repair, or part replacement on a vehicle restraint. Press ENTER button to log restraint maintenance:

```
RESTRAINT
GENERAL MAINT ▼
RESTRAINT ▲
REPAIR ▼
RESTRAINT ▲
REPLACE PART
```

- Use the SCROLL UP/DOWN buttons (**D**) to select the work that has been performed, then press ENTER button (**C**) to confirm:

```
RESTRAINT
LOGGED
```

- User will then be returned to Maintenance Entry.

# MAINTENANCE

## Maintenance (continued)

### Maintenance Entry (continued)

MAINT ENTRY ▲  
LEVELER ▼

- **Leveler Maintenance** can be selected to log general maintenance, repair, or part replacement on a dock leveler. Press ENTER button to log leveler maintenance:

LEVELER  
GENERAL MAINT ▼

LEVELER ▲  
REPAIR ▼

LEVELER ▲  
REPLACE PART

- Use the SCROLL UP/DOWN buttons to select the work that has been performed, then press ENTER button to confirm:

LEVELER  
LOGGED

- User will then be returned to Maintenance Entry.

MAINT ENTRY ▲  
DOOR ▼

- **Door Maintenance** can be selected to log general maintenance, repair, or part replacement on an overhead door. Press ENTER button to log door maintenance:

DOOR  
GENERAL MAINT ▼

DOOR ▲  
REPAIR ▼

DOOR ▲  
REPLACE PART

- Use the SCROLL UP/DOWN buttons (D) to select the work that has been performed, then press ENTER button to confirm:

DOOR  
LOGGED

- User will then be returned to Maintenance Entry.

MAINT ENTRY ▲  
PM RESET

- **PM Reset** can be selected to clear the “MAINTENANCE DUE” message and verify that Planned Maintenance has been completed, and set the date when the system will remind users that Planned Maintenance is due. Press ENTER button to complete a PM Reset:

SET NEXT PM DATE  
90▲▼ 04/01/2018

- Use the SCROLL UP/DOWN buttons to select the number of days until Planned Maintenance is due again. The date will automatically update based on the number of days defined (maximum of 90). When finished, press ENTER button to confirm:

SET NEXT PM DATE  
DATE SAVED

- User will then be returned to Maintenance Entry.



## Maintenance (continued)

### Maintenance Records

- The Maintenance Records menu allows users to see a list of iDock Control System maintenance that has been logged, from most recent to least recent. Press ENTER button to see Maintenance Records:

```
REST GNRL MAIN
01/01/18 12:00 ▼
LVLR REPAIR
12/31/17 12:00 ▲
```

- Use the SCROLL UP/DOWN buttons to see what type of maintenance has been performed, along with the completion date.

- Vehicle Restraint**

```
REST GNRL MAIN
01/01/18 12:00 ▼
```

- General Maintenance

```
REST REPAIR
01/01/18 12:00▲▼
```

- Repair

```
REST RPLCE PART
01/01/18 12:00 ▲
```

- Part Replacement

- Dock Leveler**

```
LVLR GNRL MAIN
01/01/18 12:00 ▼
```

- General Maintenance

```
LVLR REPAIR
01/01/18 12:00▲▼
```

- Repair

```
LVLR RPLCE PART
01/01/18 12:00 ▲
```

- Part Replacement

- Overhead Door**

```
DOOR GNRL MAIN
01/01/18 12:00 ▼
```

- General Maintenance

```
DOOR REPAIR
01/01/18 12:00▲▼
```

- Repair

```
DOOR RPLCE PART
01/01/18 12:00 ▲
```

- Part Replacement

- When finished browsing Maintenance Records, press the MENU button to return to the Maintenance menu.

# TROUBLESHOOTING

## Diagnostics

From the Diagnostics menu, maintenance staff and/or service providers can view system-wide diagnostic information.

To access the Diagnostics menu:

1. Press the MENU button (B). Use the SCROLL DOWN button (D) to select Settings:

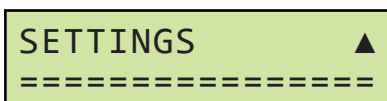

**Note:** Maintenance Code will be required to access the Settings menu if code has been changed from default.

2. Press the ENTER button (C) to enter the Settings menu, and use the SCROLL DOWN button to scroll to **Program Access**:

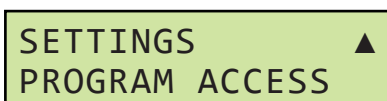

3. Press the ENTER button and use the SCROLL DOWN button to scroll to **Diagnostics**:

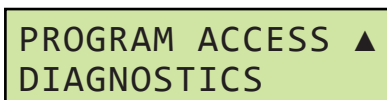

4. Press the ENTER button to proceed.

5. The following information can now be viewed. Press MENU button to exit or return to the previous menu at any time:

- **Controller Info**
- **Controller I/O**
- **Equipment**
- **Door Code History**
- **Maintenance Entry**
- **Maintenance Records**



- **Controller Info** can be selected to view information on the iDock Control System. Press ENTER button (C) and use the SCROLL UP/DOWN buttons (D) to view the following:

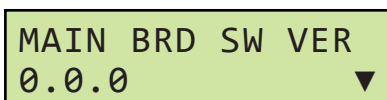

- **Software version will vary based on Mfg date.**

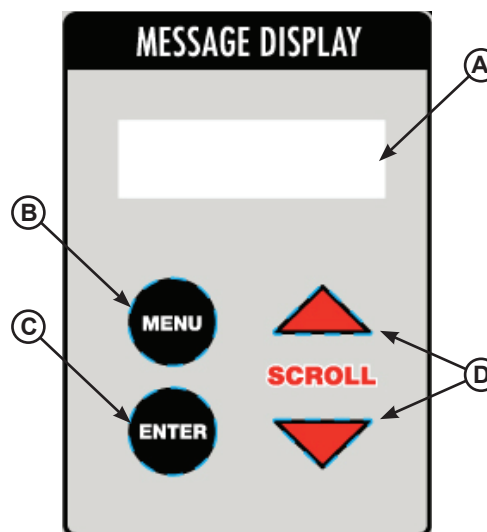

System Control Buttons/Displays

- A - Message Display
- B - MENU button
- C - ENTER button
- D - SCROLL UP/DOWN buttons

**Main Software Version** displays the currently installed main software version.

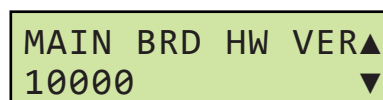

**Main Hardware Version** displays the currently installed main hardware version.

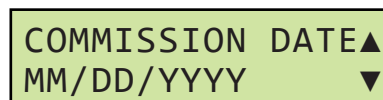

**Commission Date** displays the date that the iDock Control System factory commissioning was completed.

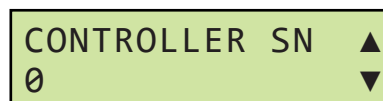

**Controller Serial Number** displays the serial number for the iDock Control System being used.

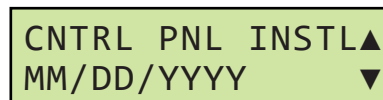

**Control Panel Install Date** displays the date that the iDock Control System field installation was completed.

## Diagnostics (continued)

DATE ▲  
MM/DD/YYYY ▼

**Date** displays the currently set date.

TIME ▲  
HH:MM:SS ▼

**Time** displays the currently set time.

TIME STAMP ▲  
MM/DD/YYYY ▼

**Time Stamp** displays the currently set time stamp format.

MAX DAYS TO PM ▲  
90 ▼

**Max Days To PM** displays the maximum currently set PM interval.

DIAGNOSTICS ▲  
CONTROLLER I/O ▼

- **Controller I/O** can be selected to view input and output information on the iDock Control System. Press ENTER button (C) and use the SCROLL UP/DOWN buttons (D) to view the following:

INPUT VOLTAGE ▲  
00.00V ▼

**Input Voltage** displays the current input voltage for the iDock Control System.

DIGITAL INPUTS ▲  
000 ▼

**Digital Inputs** displays which inputs are currently active on the main terminal board:

- **1xx** - Input 1 active
- **x1x** - Input 2 active
- **xx1** - Input 3 active

SYSLGHT CURRENT ▲  
00 ▼

**System Light Current** displays the current in milliamps for the Multi-Colored LED Light.

PRIM MEMBRANE ▲  
000000 ▼

**Primary Membrane** displays which buttons are currently being pressed on the primary membrane:

- **1xxxxx** - ENGAGE button active
- **x1xxxx** - RELEASE button active
- **xx1xxx** - RAISE button active
- **xxx1xx** - LIP button active
- **xxxx1x** - LOWER button active
- **xxxxx1** - DOCK ALERT STATUS button active

SEC MEMBRANE ▲  
0000 ▼

**Secondary Membrane** displays which buttons are currently being pressed on the secondary membrane:

- **1xxx** - OPEN button active
- **x1xx** - CLOSE button active
- **xx1x** - STOP button active
- **xxx1** - DOCK LIGHT button active

DIAGNOSTICS ▲  
EQUIPMENT ▼

- **Equipment** can be selected to view the currently configured equipment on the iDock Control System. Press ENTER button and use the SCROLL UP/DOWN buttons to view the following:

PRIMARY SLAVE ▲  
TERMINAL ▼

**Primary Slave** displays the installed terminal board variation:

- **Terminal** indicates the system is configured for a large terminal board.
- **Small Terminal** indicates the system is configured for a small terminal board.

# TROUBLESHOOTING

## Diagnostics (continued)

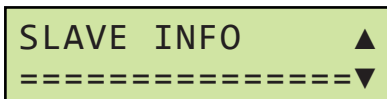

**Slave Info** displays information on the slave board when selected. Press ENTER button and use the SCROLL UP/DOWN buttons to view information on the slave board:

- **Serial Number**
- **Software Version**
- **Hardware Version**
- **Hour Counter**
- **Voltage Input**
- **Red Out Light**
- **Green Out Light**

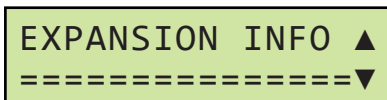

**Expansion Info** displays information on the expansion board when selected. Press ENTER button and use the SCROLL UP/DOWN buttons to view information on the slave board:

- **Serial Number**
- **Software Version**
- **Hardware Version**
- **Hour Counter**
- **Voltage Input**

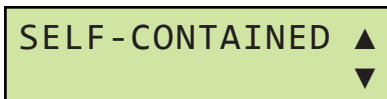

**Self-Contained** displays whether the Self-Contained restraint equipment option is enabled or disabled.



**E-Stop** displays whether the Emergency Stop equipment option is enabled or disabled.

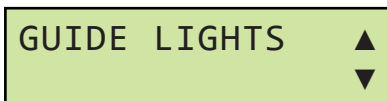

**Guide Lights** displays whether the Guide Lights equipment option is enabled or disabled.

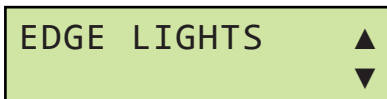

**Edge Lights** displays whether the Edge Lights equipment option is enabled or disabled.

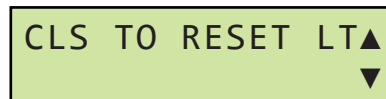

**Close To Reset Lights** displays whether the Close Door to Reset Lights equipment option is enabled or disabled.



**Vehicle Present Sensor** displays whether the Vehicle Present Sensor equipment option is enabled or disabled.

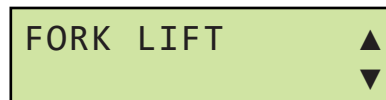

**Fork Lift** displays whether the Fork Lift Truck Sensor equipment option is enabled or disabled.

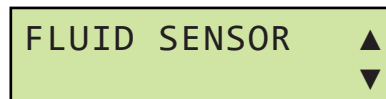

**Fluid Sensor** displays whether the Fluid Sensor equipment option is enabled or disabled.

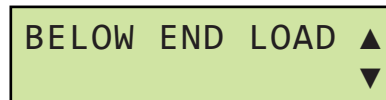

**Below End Load** displays whether the Below Dock End Load equipment option is enabled or disabled.

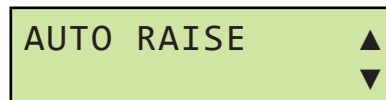

**Auto Raise** displays whether the Auto Raise for PowerHook restraint equipment option is enabled or disabled.

**This page intentionally left blank.**

# TROUBLESHOOTING

## Multi-Colored Light



Red



Amber



Green

The iDock Control System is equipped with a Multi-Colored LED Light that provides a simple and easily-understood visual reference for dock workers.

The Multi-Colored Light can display red, amber and green colors, along with various flashing patterns to provide information to the user. The Multi-Colored Light can also work with the system Message Display to troubleshoot and provide diagnostic information.

See page 59 for Multi-Colored & Outside Light Sequence Charts.

# TROUBLESHOOTING

## Multi-Colored & Outside Light Sequence Charts

### Normal Operation

Condition	Lights	
	Inside	Outside
Ready For Use	Red	Green
Transport Vehicle Present (Optional add-on. Active with restraint in stored position.)	Red (Double Flash)	Green
Leveler Operating or Restraint Engaging/Releasing In Progress	Amber	Red
Restraint Engaged	Green	Red
Restraint Engaged, Leveler Stored (optional)*	Green/Amber*	Red
Restraint Engaged, Leveler Deployed (optional)*	Green*	Red
Restraint Engage Failure	Red/Amber, Display Backlight**	Red
Emergency Stop Active	Red (solid)**	Red (solid)
Attempted Pullout (PowerHook restraints only)	Red**	Red (fast flashing)

\*Only pit leveler/vehicle restraint combo panels with optional Leveler Stored Indication will follow this sequence.

\*\*If equipped, Audible Alarm will also be active.

### Bypass Mode

Condition	Lights	
	Inside	Outside
Restraint Engage Failure (Bypass Mode prompt)	Red/Amber, Display Backlight	Red
Bypass Mode	Green/Amber (Green/Red on Dock Alert)	Red
Reset Attempted (Leveler in Use)	Red/Amber, Display Backlight	Red
Reset Attempted (Door Open)	Green/Amber, Display Backlight	Red
Reset Lights to Normal Mode	Red, Display Backlight (5 seconds)	Green

### Menu & Diagnostics

Condition	Lights	
	Inside	Outside
Main Menu Active	Red (solid)	Red (solid)
System Fault Present	Red/Amber	Red
Restraint Use Disabled	Amber	None



# TROUBLESHOOTING

## Restraint/Leveler/Door Interlocking Options

iDock Control Systems are available with many different combinations of Restraint, Leveler and Overhead Door interlocks to meet individual customer needs. See the table on page 61 for information on available interlocks; call Systems, LLC to discuss interlock options to meet your specific needs.

To see the interlock configuration for an installed iDock Control System, check the SYSTEM INFO menu with the following instructions:

1. Press the MENU button (B) and use the SCROLL UP/DOWN buttons (D) to scroll to **System Information**:

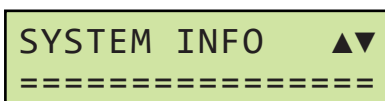

2. Press the ENTER button (C) and use the SCROLL UP/DOWN buttons to scroll to **Interlocks**:

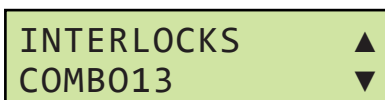

3. Verify displayed interlock with table on page 61.

**Note:** COMBO 13 is shown as an example only; actual equipment may vary.

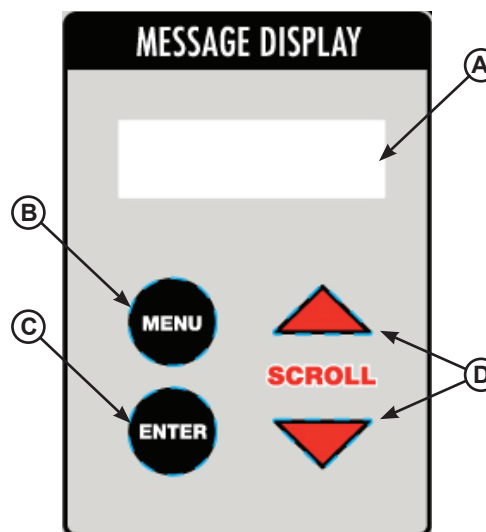

System Control Buttons/Displays

- A - Message Display
- B - Menu button
- C - Enter button
- D - Scroll Up/Down buttons

## NOTICE

The iDock Control System is designed to function with 12v DC door open/closed interlock contacts only.

Using 115v AC or other non-12v DC door open/closed contacts and wiring will cause the iDock Control System to enter a fault state and equipment will not function.

If door open/closed contacts are required for interlocking, Systems, LLC can provide 12v DC photo eyes upon request. Door open/closed contacts provided by others or external equipment may be used but must be 12v DC.

**If an overhead door operator will be used for door open/closed interlock contacts, it must be equipped with auxiliary contacts for this purpose.**



# TROUBLESHOOTING

## Interlocking Options Chart

Description	Option Code	iDock Options Required	Equipment Required
Door Opened before Leveler Operates	N/A (Standard)	None	<ul style="list-style-type: none"> <li>Overhead door operator with auxiliary Door Open contact or Door Open sensor</li> </ul>
Restraint Engaged (or in Bypass) before Leveler Operates	RELO (1)	None	None
Restraint Engaged (or in Bypass) before Door Opens	REDO (2)	<ul style="list-style-type: none"> <li>Overhead Door Controls</li> </ul>	None
Leveler Stored before Restraint Releases	LSRR (3)	None	<ul style="list-style-type: none"> <li>Dock leveler with Leveler Stored contact</li> </ul>
Leveler Stored before Door Closes	LSDC (4)	<ul style="list-style-type: none"> <li>Overhead Door Controls</li> </ul>	<ul style="list-style-type: none"> <li>Dock leveler with Leveler Stored contact</li> </ul>
Door Opened before Restraint Engages	DORE (5)	None	<ul style="list-style-type: none"> <li>Overhead door operator with auxiliary Door Open contact or Door Open sensor</li> </ul>
Door Closed before Restraint Releases	DCRR (6)	None	<ul style="list-style-type: none"> <li>Overhead door operator with auxiliary Door Closed contact or Door Closed sensor</li> </ul>
Restraint Engaged (or in Bypass) before Leveler Operates Leveler Stored before Restraint Releases	COMBO RELO/LSRR (COMBO 13)	None	<ul style="list-style-type: none"> <li>Dock leveler with Leveler Stored contact</li> </ul>
Restraint Engaged (or in Bypass) before Door Opens Door Closed before Restraint Releases	COMBO REDO/DCRR (COMBO 26)	<ul style="list-style-type: none"> <li>Overhead Door Controls</li> </ul>	<ul style="list-style-type: none"> <li>Overhead Door Operator with auxiliary Contacts or Door Sensors</li> </ul>
Restraint Engaged (or in Bypass) and Door Open before Leveler Operates Leveler Stored before Restraint Releases or Door Closes	COMBO RELO/LSRR/LSDC (COMBO 134)	<ul style="list-style-type: none"> <li>Overhead Door Controls</li> </ul>	<ul style="list-style-type: none"> <li>Dock leveler with Leveler Stored contact</li> <li>Overhead door operator with auxiliary Door Open contact or Door Open sensor</li> </ul>
Restraint Engaged (or in Bypass) before Leveler Operates Restraint Engaged (or in Bypass) before Door Opens Leveler Stored before Restraint Releases Leveler Stored before Door Closes Door Closed before Restraint Releases	COMBO RELO/REDO/LSRR/LSDC/DCRR (COMBO 12346)	<ul style="list-style-type: none"> <li>Overhead Door Controls</li> </ul>	<ul style="list-style-type: none"> <li>Dock leveler with Leveler Stored contact</li> <li>Overhead door operator with auxiliary Door Open &amp; Door Closed contacts or Door Open &amp; Door Closed sensors</li> </ul>
Door Open before Restraint Engages Restraint Engaged (or in Bypass) before Leveler Operates Leveler Stored before Restraint Releases Leveler Stored before Door Closes	COMBO DORE/RELO/LSRR/LSDC (COMBO 5134)	<ul style="list-style-type: none"> <li>Overhead Door Controls</li> </ul>	<ul style="list-style-type: none"> <li>Dock leveler with Leveler Stored contact</li> </ul>

# TROUBLESHOOTING

---

## iDock Fault Codes

### **CAUTION**

A safe work environment requires all equipment to be working correctly. DO NOT use a malfunctioning iDock Control System or any other loading dock equipment with broken or missing parts.

The iDock Control System is capable of diagnosing and reporting faults as they occur; the fault history is accessible by maintenance staff and/or service providers in the Maintenance menu (see page 50).

If your iDock Control System is displaying a fault code, please contact your maintenance staff and/or service provider with equipment and fault information.

See the following tables for fault code details:

Page 65: System Faults

Page 66: Dock Leveler Faults

Page 67: TPR/UniLock Restraint Faults

Page 68: PowerStop/Stop-Tite Restraint Faults

Page 69: PowerHold/Hold-Tite Restraint Faults

Page 70: PowerHook Restraint Faults

**If troubleshooting assistance is required, contact  
Systems, LLC Technical Services.**

**Toll Free: 800-643-5424**

**E-Mail: [techservices@loadingdocksystems.com](mailto:techservices@loadingdocksystems.com)**

# TROUBLESHOOTING

## System Faults

#	Fault	Cause	Troubleshooting
1	<b>RED OSLA FAIL (RED OUTSIDE LIGHT FAILURE)</b>	Red outside light current draw is 0 amps.	Check outside light for damage or failure. Check field wiring connections at terminal board and outside light. Check outside light for correct voltage (12v).
2	<b>GRN OSLA FAIL (GREEN OUTSIDE LIGHT FAILURE)</b>	Green outside light current draw is 0 amps.	Check outside light for damage or failure. Check field wiring connections at terminal board and outside light. Check outside light for correct voltage (12v).
3	<b>IN LIGHT FAIL (INSIDE LIGHT FAILURE)</b>	Inside LED assembly current draw is 0 amps.	Check inside LED cable connection to main board. Check inside LED cable for cuts or kinks. Check inside LED solder connections for damage or breaks. Check main board for damage near LED cable connection.
4	<b>DOUBLE GREEN LIGHT FAILURE</b>	Inside LED assembly and outside light assembly are green. This is not a permissible state	Cycle power. Check field wiring connections at terminal board and outside light assembly. If problem persists, contact systems technical services.
50	<b>LOW VOLTAGE (LOW SYSTEM VOLTAGE)</b>	Low input voltage from 12v power supply to terminal board.	Verify sufficient line voltage input to control box. Adjust 12v power supply to ensure voltage output is 12 VDC or higher. Replace 12v power supply if voltage input is adequate yet voltage output cannot be adjusted over 12 VDC.
51	<b>CRC CHECK (CRC CHECK ERROR)</b>	Memory or configuration error.	Cycle power. If problem persists, update main board firmware via SD card. If problem still persists, contact Systems Technical Services.
52	<b>COMM LOSS (COMMUNICATION LOSS)</b>	Communication loss between main board and terminal board.	Cycle power. Inspect RJ45 cable for damage to connectors, kinks, or cuts. If fault resets but is reoccurring, contact Systems Technical Services.
53	<b>EXP COMM (EXPANSION BRD COMMUNICATE ERR)</b>	Communication loss between terminal board and expansion board.	Cycle power. If problem persists, check and re-seat connection between boards. If problem still persists, contact Systems Technical Services.
54	<b>MAIN COMM (TERMINAL BRD COMMUNICATE ERR)</b>	Communication loss between main board and terminal board.	Cycle power. Inspect RJ45 cable for damage to connectors, kinks, or cuts. If problem persists, Contact Systems Technical Services.

# TROUBLESHOOTING

## Dock Leveler Faults

#	Fault	Cause	Troubleshooting
27	<b>MAX RT EXC'D (LEVELER MAX RUNTIME EXCEEDED)</b>	Leveler motor/pump has been continuously running for too long.	Check membrane for damage to RAISE button. Check motor/pump operation. Check pressure relief valve for proper setting. Check hydraulic system for fluid leaks.
30	<b>MAX RT EXC'D (LEVELER MAX RUNTIME EXCEEDED)</b>	Blower motor has been continuously running for too long.	Check membrane for damage to RAISE button. Check blower motor operation. Check lifting system for air leaks.
31	<b>HYD FLD LVL (LOW LEVELER HYD FLUID LEVEL)</b>	Oil level sensor has turned OFF.	Check fluid sensor for proper placement and operation. Verify field wiring to fluid sensor. Check hydraulic system for fluid leaks.
32	<b>FAIL 2 DPLOY (LVLR FAIL TO DEPLOY IN TIME)</b>	Leveler stored sensor remains ON too long after beginning operation.	Bleed hydraulic system if not already completed. Check for and clear obstructions if present. Check lip prox/stored limit switch for proper operation. Verify field wiring to lip prox/ stored limit switch. Check motor/pump operation during cycle.

# TROUBLESHOOTING

## TPR/UniLock Restraint Faults

#	Fault	Cause	Troubleshooting
5	<b>REENGAGE FAIL (REENGAGEMENT FAILURE)</b>	Restraint attempted auto re-engage and failed.	Check for and clear obstructions or RIG wedge if present. Check LS1 limit switch for correct open/close operation. Check for chain or motor failure.
6	<b>STAY STORED (RESTRAINT STAYED STORED)</b>	Restraint stored limit/prox switch remains on too long after pressing ENGAGE.	Check for and clear obstructions or RIG wedge if present. Check moving components for binding or damage. Check LS2 limit switch for correct open/close operation. Check for chain or motor failure.
7	<b>STAY WRK ZONE (RESTRAINT STAYED ENGAGED)</b>	Working zone limit/prox switch remains on too long after pressing RELEASE.	Check for and clear obstructions or RIG wedge if present. Check moving components for binding or damage. Check LS1 & LS2 limit switch for correct open/close operation. Check for chain or motor failure.
8	<b>NO RTN 2 STRD (RESTRAINT DID NOT STORE)</b>	Both working zone and stored sensors remain off too long after pressing RELEASE.	Check for and clear obstructions or RIG wedge if present. Check moving components for binding or damage. Check LS2 limit switch for correct open/close operation. Check for chain or motor failure.
9	<b>RST SNSRS ON (BOTH RESTRAINT SENSORS ON)</b>	Both working zone (LS1) and stored (LS2) sensors are ON at the same time.	Check LS1 & LS2 limit switch for correct open/close operation. Verify field wiring to LS1 & LS2 limit switches.

# TROUBLESHOOTING

## PowerStop/Stop-Tite Restraint Faults

#	Fault	Cause	Troubleshooting
6	<b>STAY STORED (RESTRAINT STAYED STORED)</b>	Restraint stored limit/prox switch remains on too long after pressing ENGAGE.	Check for and clear obstructions if present. Check moving components for binding or damage. Check prox switches for correct open/close operation. Check motor/pump operation.
7	<b>STAY WRK ZONE (RESTRAINT STAYED ENGAGED)</b>	Working zone limit/prox switch remains on too long after pressing RELEASE.	Check for and clear obstructions if present. Check moving components for binding or damage. Check prox switches for correct open/close operation. Check motor/pump operation.
8	<b>NO RTN 2 STRD (RESTRAINT DID NOT STORE)</b>	Both working zone and stored sensors remain off too long after pressing RELEASE.	Check for and clear obstructions if present. Check moving components for binding or damage. Check prox switches for correct open/close operation. Check motor/pump operation.
12	<b>RST SNSRS ON (BOTH RSTRAINT SENSORS ON)</b>	Both RIG and stored sensors are ON at the same time.	Check for and clear obstructions if present. Check trailer for unusually low RIG bar when air suspension is fully purged. Check RIG sensor and prox switch for proper operation. Check motor/pump operation.

# TROUBLESHOOTING

## PowerHold/Hold-Tite Restraint Faults

#	Fault	Cause	Troubleshooting
6	<b>STAY STORED (RESTRAINT STAYED STORED)</b>	Restraint stored limit/prox switch remains on too long after pressing ENGAGE.	Check for and clear obstructions if present. Check moving components for binding or damage. Check prox switches for correct open/close operation. Check motor/pump operation.
8	<b>NO RTN 2 STRD (RESTRAINT DID NOT STORE)</b>	Both working zone and stored sensors remain off too long after pressing RELEASE.	Check for and clear obstructions if present. Check moving components for binding or damage. Check prox switches for correct open/close operation. Check motor/pump operation.
14	<b>RST RT EXC'D (RSTNT ENGAGE RUNTIME EXCEEDED)</b>	Restraint raised sensor remains OFF too long after pressing ENGAGE.	Check for and clear obstructions if present. Check raised prox switch for proper operation. Check hydraulic components, slide block, and rack weldment for binding or damage. Check motor/pump operation.
15	<b>RST NOT STRD (RESTRAINT NOT STORED)</b>	Engaged, raised and stored sensors are all OFF while unit sits idle.	Check stored prox switch for proper operation. Verify field wiring to stored prox switch. Check junction box for water intrusion.
16	<b>RST INV ENG (RSTNT INVALID ENGAGEMENT)</b>	Engaged sensor is ON, both raised and stored sensors are OFF while unit sits idle.	Check engaged prox switch for proper operation. Verify field wiring to engaged prox switch. Check junction box for water intrusion.
17	<b>RST INV RAIS (RSTNT INVALID RAISE POSITION)</b>	Raised sensor is ON, both engaged and stored sensors are OFF while unit sits idle.	Check raised prox switch for proper operation. Verify field wiring to raised prox switch. Check push rod, Z-bar and spring for binding or damage. Verify Z-bar is not stuck over prox switch. Check junction box for water intrusion.
18	<b>STRD &amp; ENG'D (STRD &amp; ENG'D SENSORS ON)</b>	Both engaged and stored sensors are ON at the same time.	Check prox switches for proper operation. Verify field wiring to prox switches. Check latch block and rack weldment for binding or damage. Verify rack weldment is not stuck over prox switch. Check junction box for water intrusion.
19	<b>STRD &amp; RAISE (STRD &amp; RAISED SENSORS ON)</b>	Both raised and stored sensors are ON at the same time.	Check prox switches for proper operation. Verify field wiring to prox switches. Check push rod, Z-bar and spring for binding or damage. Verify Z-bar is not stuck over prox switch. Check junction box for water intrusion.

# TROUBLESHOOTING

## PowerHook Restraint Faults

#	Fault	Cause	Troubleshooting
6	<b>STAY STORED (RESTRAINT STAYED STORED)</b>	Innermost guide track sensor remains on too long after pressing ENGAGE.	Check for and clear obstructions if present. Check innermost guide track prox switch for proper operation. Check motor/pump operation.
20	<b>FAIL 2 EXTND (FAILED TO EXTEND IN TIME)</b>	Outermost guide track sensor remains ON too long after Hook attempts extending.	Check for and clear obstructions if present. Check outermost guide track prox switch for proper operation. Check motor/pump operation.
21	<b>FAIL 2 ENGAG (FAILED TO ENGAGE IN TIME)</b>	Middle guide track sensor AND pressure switch remain OFF too long after Hook attempts retracting.	Check for and clear obstructions if present. Check middle guide track prox switch for proper operation. Verify field wiring to C1 & C2 solenoid coils. Verify field wiring to pressure differential switch. Check motor/pump operation.
22	<b>FAIL 2 LOWER (FAILED TO LOWER IN TIME)</b>	Trunnion sensor remains OFF too long after Hook attempts lowering.	Check for and clear obstructions if present. Check rear trunnion prox switch for proper operation. Verify field wiring to B & D solenoid coils. Check motor/pump operation.
23	<b>FAIL 2 RTRCT (FAILED TO RETRACT IN TIME)</b>	Innermost guide track sensor AND pressure switch remain OFF too long after Hook attempts retracting.	Check for and clear obstructions if present. Check innermost guide track prox switch for proper operation. Verify field wiring to C1 & C2 solenoid coils. Verify field wiring to pressure differential switch. Check motor/pump operation.
24	<b>FAIL 2 RAISE (FAILED TO RAISE IN TIME)</b>	Trunnion sensor remains ON too long after Hook attempts raising.	Check for and clear obstructions if present. Check rear trunnion prox switch for proper operation. Verify field wiring to B & D solenoid coils. Check motor/pump operation during cycle.
25	<b>MAX RT EXC'D (RESTRAINT MAX RUNTIME EXCEEDED)</b>	Restraint motor/pump has been continuously running for too long without completing cycle.	Check for and clear obstructions if present. Check all guide track prox switches for proper operation. Check motor/pump operation. Check pressure relief valve for proper setting.
26	<b>FAIL 2 EXTND (FAILED TO EXTEND IN TIME)</b>	Outermost guide track sensor remains ON too long after Hook attempts extending.	Check for and clear obstructions if present. Check outermost guide track prox switch for proper operation. Check motor/pump operation.
28	<b>WZ SNSR FAIL (WORKING ZONE SENSOR FAILURE)</b>	Innermost guide track sensor is ON while middle guide track sensor is OFF.	Check all guide track prox switches for proper operation. Verify field wiring to all guide track prox switches.



## PowerHook Restraint Faults (continued)

#	Fault	Cause	Troubleshooting
29	<b>FX SNSR FAIL (EXTENDED SENSOR FAILURE)</b>	Innermost guide track sensor or middle guide track sensor is ON while outermost guide track sensor is OFF.	Check all guide track prox switches for proper operation. Verify field wiring to all guide track prox switches.
33	<b>PSI SWITCH (PRESSURE SWITCH ACTIVATED)</b>	Innermost guide track sensor is OFF while pressure switch is ON after Hook attempts retracting.	Check for and clear obstructions if present. Check innermost guide track prox switch for proper operation. Verify field wiring to C1 & C2 solenoid coils. Verify field wiring to pressure differential switch. Check motor/pump operation.

# TROUBLESHOOTING

## LiftMaster® MAS Codes

When a LiftMaster® Maintenance Alert System (MAS)-capable Logic 5.0 commercial door operator is interfaced with the iDock Control System, the Control System is capable of diagnosing and reporting LiftMaster® MAS codes as they occur; the code history is accessible by maintenance staff and/or service providers in the Maintenance menu. If your iDock Control System is displaying a MAS code, please contact your maintenance staff and/or service provider with equipment and fault information.

See the following tables for code details. For more information on MAS codes and reset instructions, see LiftMaster® Installation Manual.

 <b>CAUTION</b>
<p>A safe work environment requires all equipment to be working correctly. DO NOT use a malfunctioning iDock Control System or any other loading dock equipment with broken or missing parts.</p>

#	Fault	Symptom	Solution
D1	<b>DOOR CONTROL MAS CODE ACTIVE</b>	Normal operation.	The MAS has been triggered by a cycle or month count. See LiftMaster® Installation Manual for reset instructions.
D2	<b>NO RPM INPUT DURING OPEN/CLS</b>	The door only responds to constant pressure commands.	Clutch is slipping, adjust clutch, or verify RPM sensor connection or replace RPM sensor.
D3	<b>MAX RUN TIMER HAS TIMED OUT</b>	The door stops before reaching the desired time.	Check the operator for any faults (e.g. , bad limit switch), program the Max Run Timer OR reset to factory defaults.
D4	<b>OBSTRUCTION DURING CLOSING</b>	Operator will reverse to OPEN position.	Remove obstruction or realign photoelectric sensor.
D5	<b>BUTTON ERROR</b>	The control station will not respond.	The control station must be fixed or replaced before it will be recognized as an input.
D6	<b>INVALID OPTION CARD PLUGGED IN</b>	Option card will not function properly.	Refer to LiftMaster® Installation Manual accessories page for list of supported option card(s).
D7	<b>PHOTO EYE ERROR OR REMOVED</b>	Normal operation (5 second constant pressure override required to close).	Cleared when entrapment protection device is cleared or connected.
D8	<b>UNDER VOLTAGE ERROR OR REMOVED</b>	Operator will run as long as enough power is present.	1. Check AC line for voltage. 2. Check transformer secondary for low voltage. Too many accessories may be connected to the transformer.
D9	<b>POWER BOARD FAILURE</b>	No operator movement.	Replace power board.
D10	<b>NOT IN PRGM MODE/JUMPER CHG</b>	The phase will not change.	Enter programming mode and move phase jumper to change phase.
D11	<b>OVER VOLTAGE ERROR</b>	Operator will run as long as a component failure does not occur.	1. Check AC line for voltage. 2. Voltage to be within +/- 10% of intended voltage.
D12	<b>CURRENT SENSE FAULT</b>	Motor moves for limited cycles, then motor no longer moves.	1. Check current sense wiring connection. 2. Cycle operator power after wiring has been corrected.

## LiftMaster® MAS Integration Retrofit Kit



For iDock Controls not originally ordered with the LiftMaster® MAS Logic 5.0 Integration option, the components can be purchased as a kit and field installed. **The Logic 5.0 Interface Kit, part number 7147-0001, includes everything required to retrofit LiftMaster® MAS Logic 5.0 Integration on iDock Controls.**

**Note:** The iDock system must be running firmware version 1.4.9 or later to use Logic 5.0 integration. Units with firmware version 1.4.8 or earlier will additionally require an update via SD card to install the latest firmware. The current firmware version can be verified in the Diagnostics sub-menu (Main Menu ► Settings ► Program Access ► Diagnostics ► Controller Info).

**Systems, LLC is not responsible for any time lost if the firmware is not checked and/or a required update SD card is not utilized before attempting to install the Logic 5.0 Interface Retrofit.**

### Interested in the LiftMaster® MAS Integration Retrofit Kit?

We are here to assist you Monday through Friday from 8am-4:30pm CST.  
Call us at 262-255-1510 or toll free at 1-800-643-5424. E-mail us at [Sales@LoadingDockSystems.com](mailto:Sales@LoadingDockSystems.com).

# PARTS

## External Components

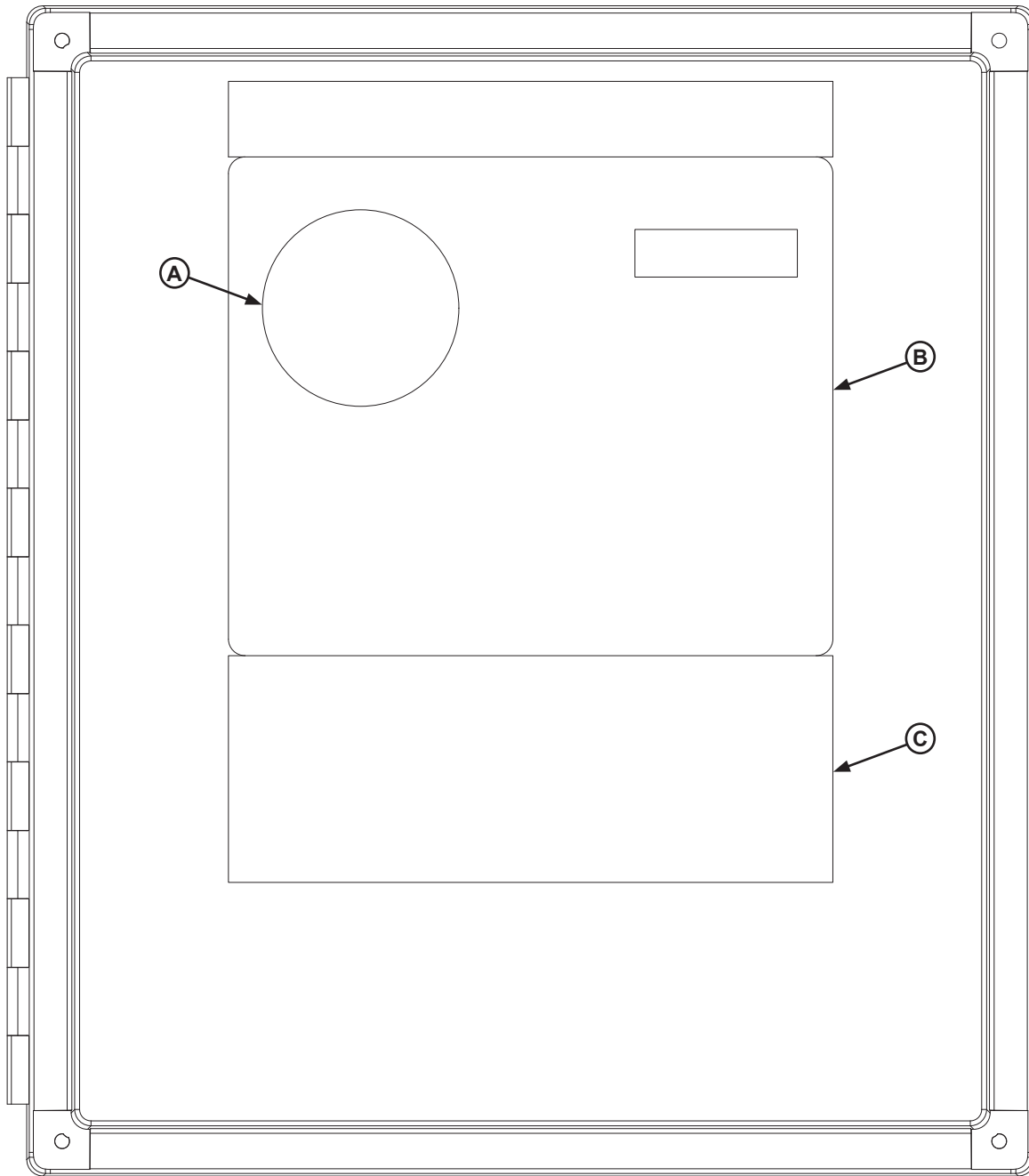

Item	Quantity	Part Number	Description
A	1	0961-0002	LED Light Board Assembly
B	1	*	Primary Pushbutton Membrane
C	1	*	Secondary Pushbutton Membrane

*\*Provide iDock Control System serial number when e-mailing, calling or faxing orders.*

## Internal Components

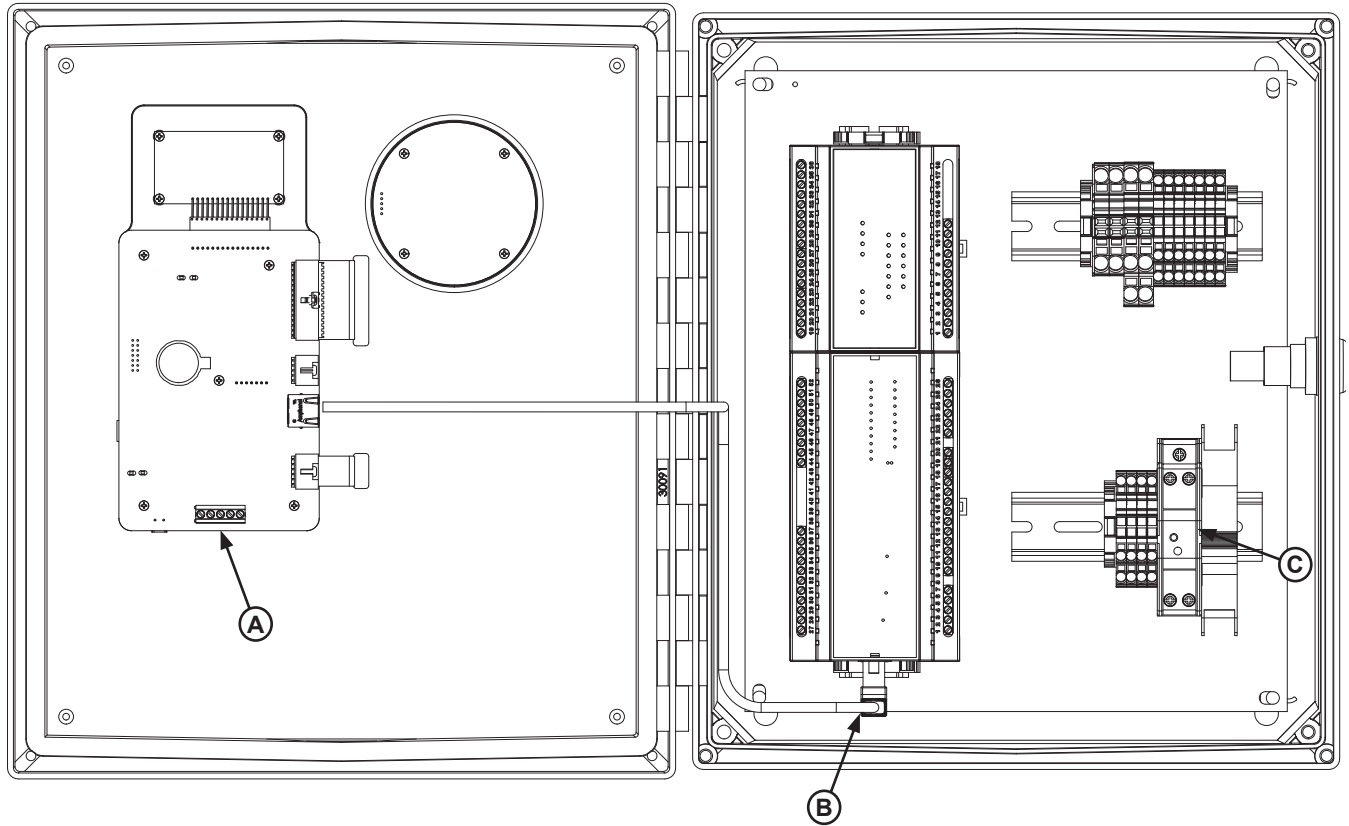

Item	Quantity	Part Number	Description
A	1	0965-0001*	Main Board
B	1	4305-0618	RJ45 Cable
C	1	1841-0143*	Power Supply, 30W
		1841-0146*	Power Supply, 60W (not pictured)

\*Provide iDock Control System serial number when e-mailing, calling or faxing orders.

# PARTS

## Terminal/Expansion Boards

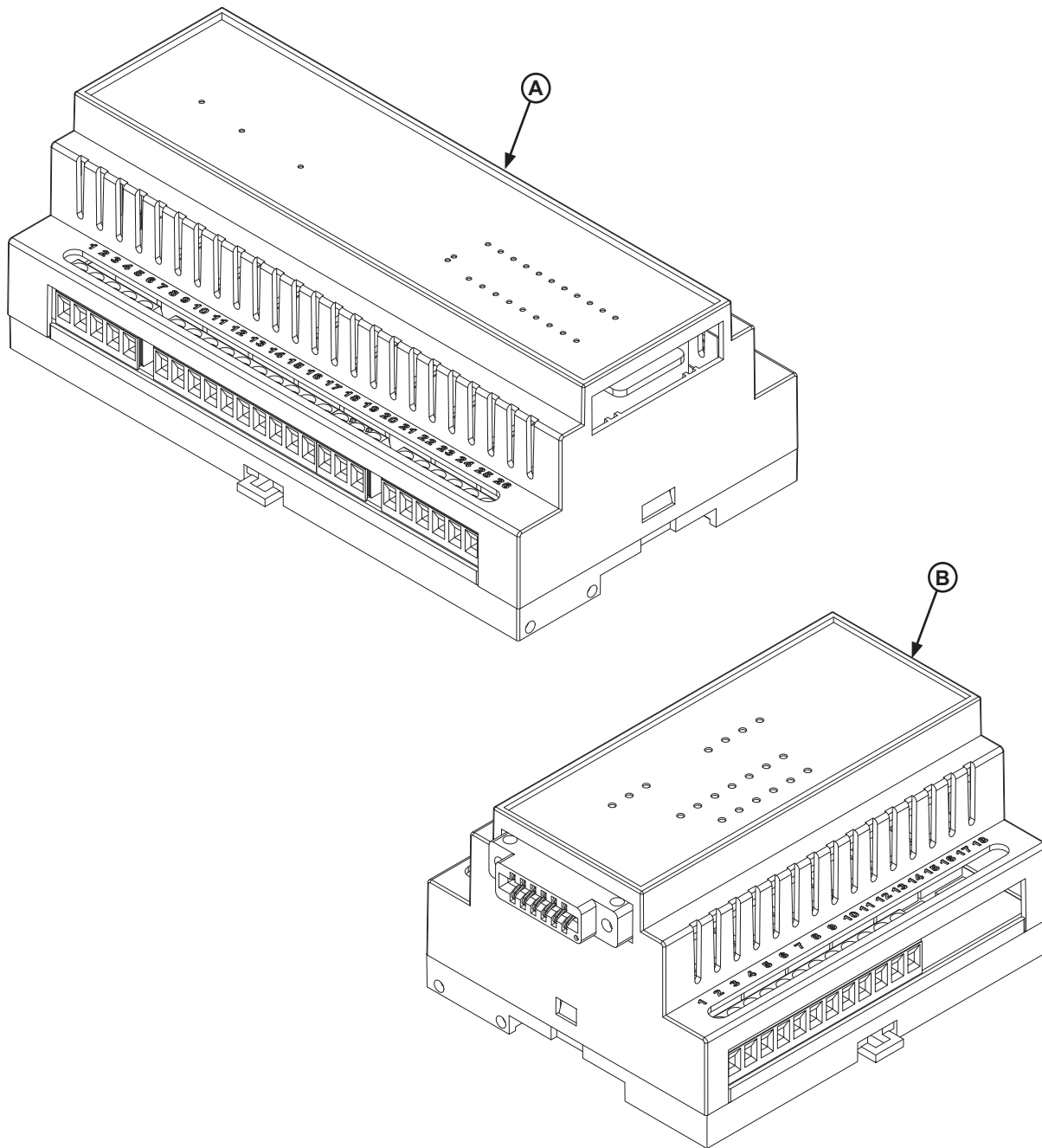

Item	Quantity	Part Number	Description
A	1	7141-0359*	Terminal Board, Large
		7141-0358*	Terminal Board, Small (not pictured)
B	1	7141-0360*	Expansion Board

\*Provide iDock Control System serial number when e-mailing, calling or faxing orders.

## OSLA (Outside Light Assembly)

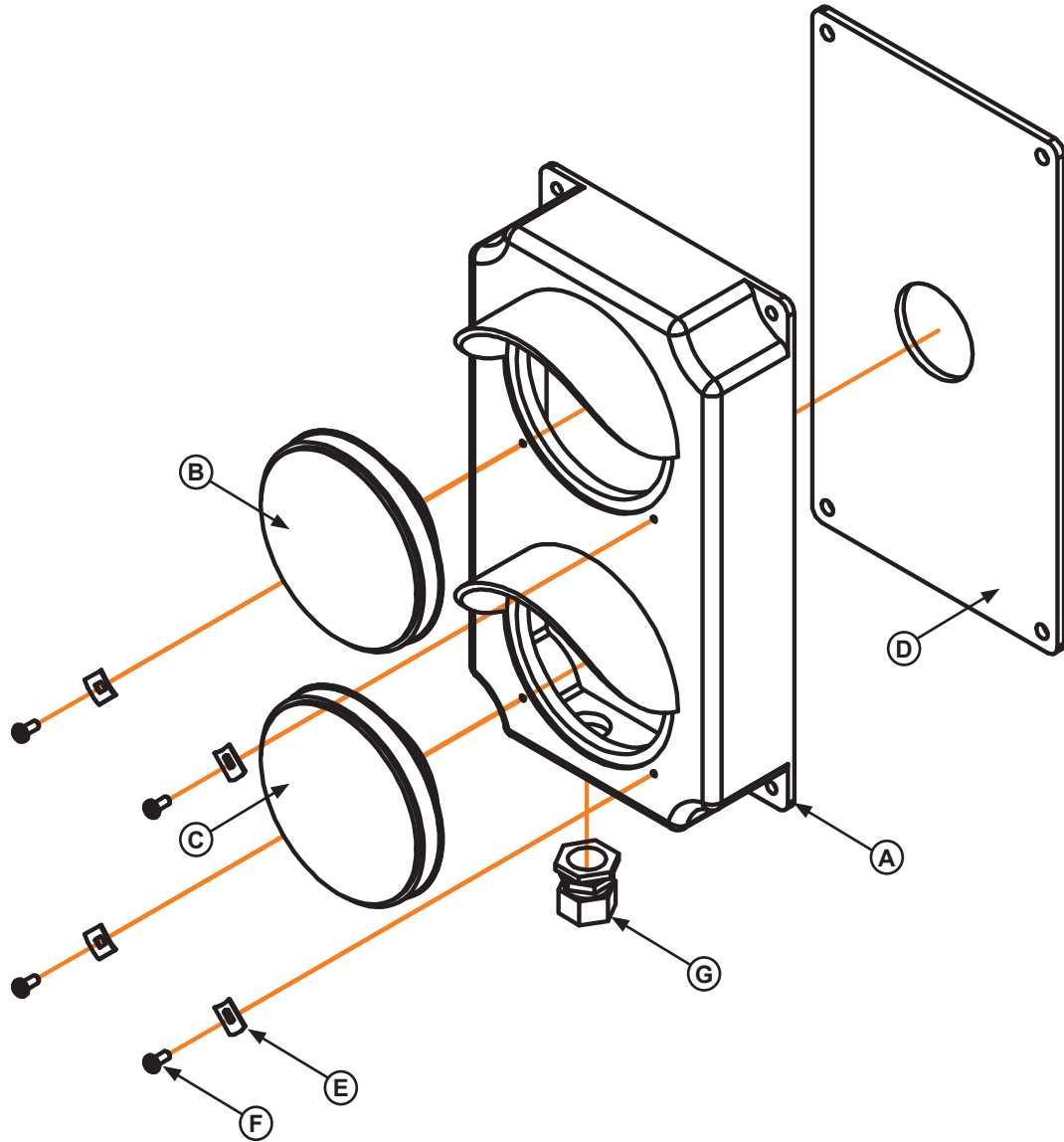

Item	Quantity	Part Number	Description
*	1	3055-0011	Complete Light Housing, Yellow Plastic, With 12v LED Lights*
A	1	3051-0002	Light Housing Only, Yellow Plastic
B	1	3051-0147	Red LED Lens/Housing/Circuit Assembly, 12v
C	1	3051-0149	Green LED Lens/Housing/Circuit Assembly, 12v
D	1	3051-0068	Mounting Gasket
E	4	3051-0105	Clip, Lens Holding
F	4	3051-0104	Screw, Lens Holding
G	1	*	Conduit Fastener, 3/4" x 3/8"

# PARTS

## Signs



A



C



B

Item	Part Number	Description
A	1751-0033	Outside Sign, Pull In/Out
B	1751-0034	Outside Sign, Pull In/Out (Mirror Image)
C	1751-0036	Inside Sign, Enter On Green Only



**This page intentionally left blank.**

# MISCELLANEOUS

## iDock Sensors

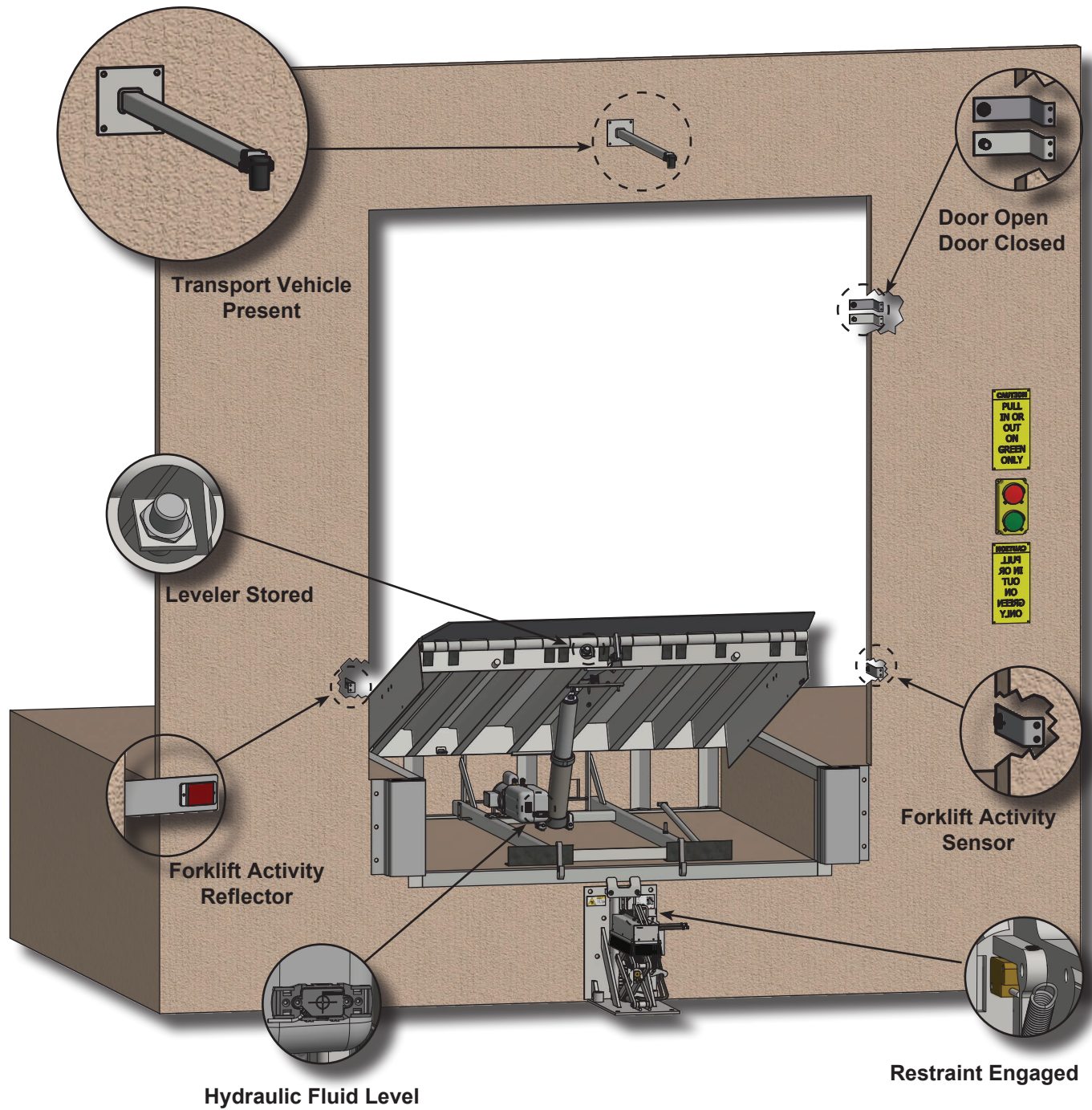

## iDock Sensors

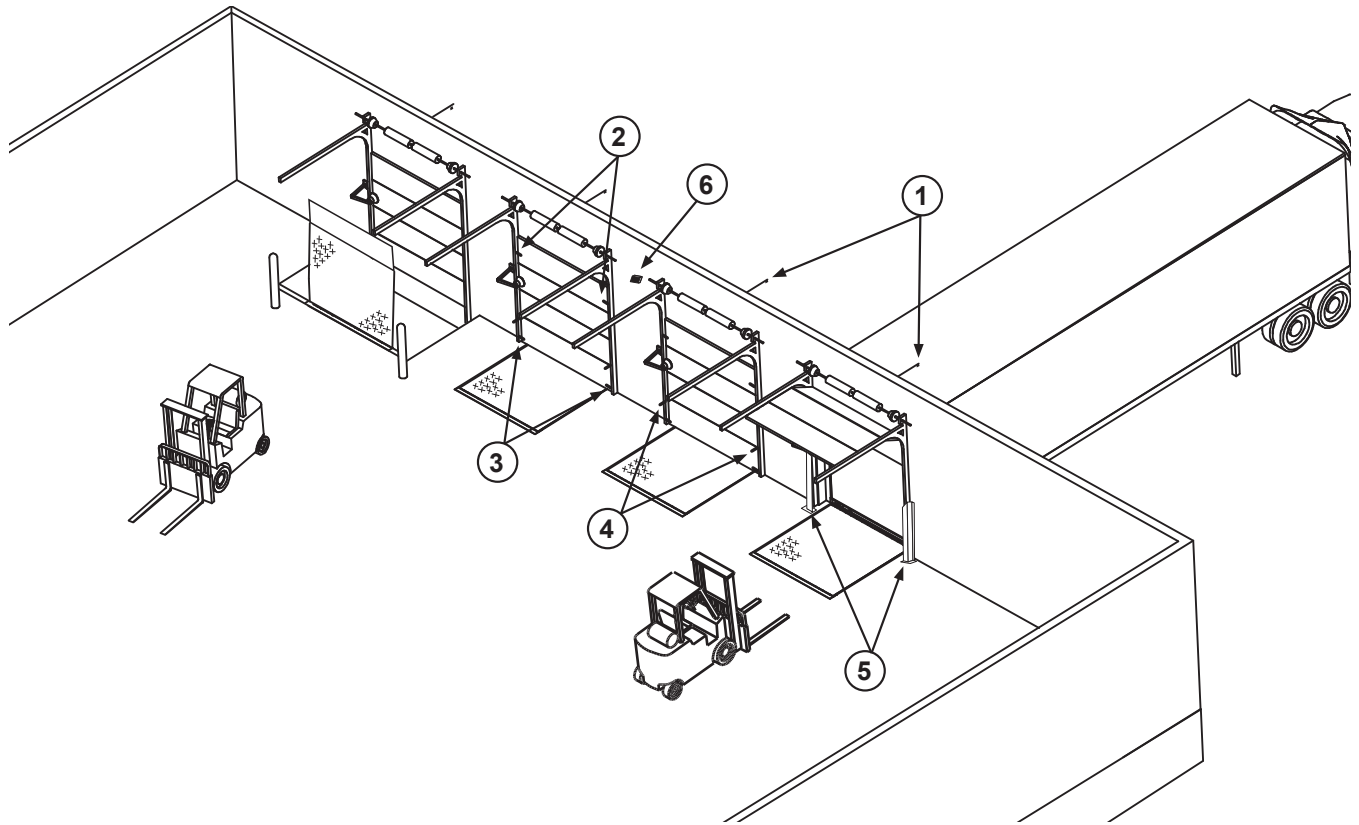

With optional iDock Sensors, the iDock Control System can log detailed dock and door cycle count and traffic information for future reference:

- Truck Present Sensors log each time a transport vehicle is present at a dock position.
- Door Open and Door Closed provide data on how long facility doors are left open, and can also be incorporated into interlock sequences.
- Forklift Activity Sensors track each time a forklift enters or exits a transport vehicle.
- Fluid Sensors notify the equipment operator when the dock leveler or vehicle restraint is running low on hydraulic fluid.

Loading dock sensors and iDock Controls from brands of Systems can also send data to the cloud with iDock Connect, an online software of loading dock analytics. See page 78 for more information on iDock Connect.

### Interested in iDock Sensors?

We are here to assist you Monday through Friday from 8am-4:30pm CST.  
Call us at 262-255-1510 or toll free at 1-800-643-5424. E-mail us at [Sales@LoadingDockSystems.com](mailto:Sales@LoadingDockSystems.com).

# MISCELLANEOUS



Monitor and improve your loading dock efficiency online with iDock Connect. Once your dock equipment from brands of Systems is installed with iDock Controls and paired with an iDock Gateway, simply create an online account at iDockConnect.com and review the analytics of your loading dock activity.

## Current Dock Activity

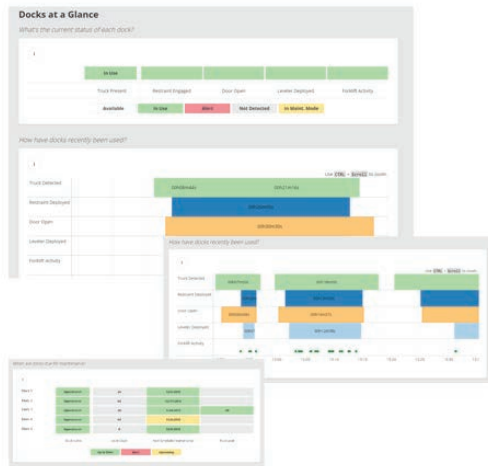

## Dock Activity Over Time

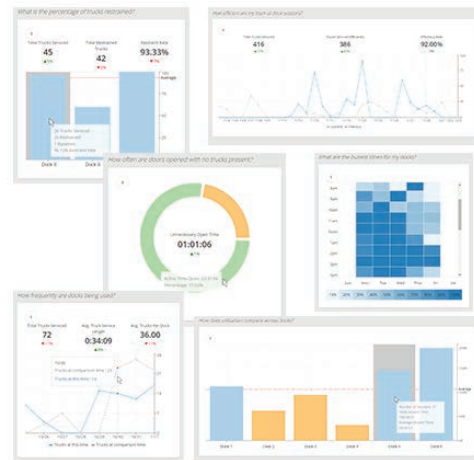

From your dashboard with iDock Connect, you can quickly review the current status of all your loading docks, which docks are available, what the current or most recent activity has been, and how all of the docks have recently been performing.

Analyze your dock activity during a selected period of time and compare it to a previous period. This allows you to monitor changes in loading efficiency, compare each dock performance, and analyze when your docks are most utilized.

## Notifications

With iDock Connect, you can receive email and/or text message alerts of loading dock events, such as maintenance past due, after-hours activity, doors left open, truck arrival/departure, and many more.



**Boost Productivity**



**Simplify Maintenance**



**Prioritize Safety**



**Tighten Security**

## Want to see iDock Connect in action?

We are here to assist you Monday through Friday from 8am-4:30pm CST.  
Call us at 262-255-1510 or toll free at 1-800-643-5424. E-mail us at [Sales@LoadingDockSystems.com](mailto:Sales@LoadingDockSystems.com).

## Customer Information

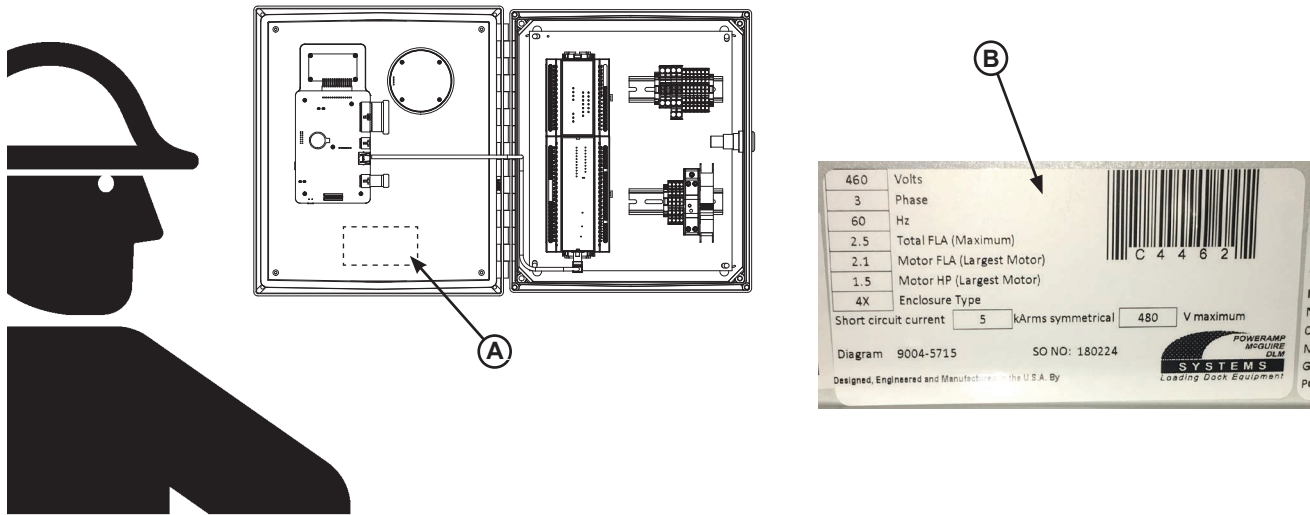

**NOTE:** Refer to figures for orientation of control box and example of decal.

The CONTROL BOX model/serial number decal is located on the inside of the enclosure door (A).

When you receive your new equipment, write down the model and serial number in the form provided. This will help ensure safe keeping of the numbers in the event the model/serial number decal (A, B) becomes lost or damaged.

Also, write down Systems, LLC's job number, the company that installed the dock leveler, and the original owner's name. This will all help to identify the specific dock leveler if more information is required.

When ordering, use part numbers and description to help identify the item ordered. Do not use "item" numbers. These are only for locating the position of the parts. Always give dock leveler MODEL NUMBER and/or SERIAL NUMBER.

For service, call or contact:

Systems, LLC  
 P.O. Box 309  
 Germantown, WI 53022

Phone: (800) 643-5424  
 Fax: (262) 255-5917

www.loadingdocksystems.com

<u>iDock Control System Information</u>	
Model	_____
Serial No.	_____
Systems, LLC, Job No.	_____
<u>Dock Leveler Information</u>	
Model	_____
Serial No.	_____
Systems, LLC, Job No.	_____
<u>Vehicle Restraint Information</u>	
Model	_____
Serial No.	_____
Systems, LLC, Job No.	_____
<u>Original Owner Information</u>	
Name	_____
Address	_____
	_____
<u>Installer Information</u>	
Name	_____
Address	_____
	_____
Date of Installation	_____

## **STANDARD PRODUCT WARRANTY**

SYSTEMS, LLC warrants that its products will be free from defects in design, materials and workmanship for a period of one (1) year from the date of shipment. All claims for breach of this warranty must be made within 30 days after the defect is or can with reasonable care, be detected. In no event shall any claim be made more than 30 days after this warranty has expired. In order to be entitled to the benefits of this warranty, the product must have been properly installed, maintained and operated in accordance with all manufacturer's recommendations and/or specified design parameters and not otherwise have been subject to abuse, misuse, misapplication, acts of nature, overloading, unauthorized repair or modification, application in a corrosive environment or lack of maintenance. Periodic lubrication, adjustment and inspection in accordance with all manufacturers' recommendations are the sole responsibility of the Owner/User.

In the event of a defect, as determined by SYSTEMS LLC, covered by this warranty, SYSTEMS LLC shall remedy such defect by repairing or replacing any defective equipment or parts, bearing the cost for the parts, labor and transportation. This shall be exclusive remedy for all claims whether based on contract, negligence or strict liability.

## **WARRANTY LIMITATIONS**

THE ABOVE WARRANTIES ARE IN LIEU OF ANY OTHER WARRANTIES, WHETHER EXPRESSED OR IMPLIED, INCLUDING BUT NOT LIMITED TO ANY IMPLIED WARRANTY OF MERCHANTABILITY OR FITNESS FOR A PARTICULAR PURPOSE. SYSTEMS LLC AND ITS SUBSIDIARIES SHALL NOT IN ANY EVENT BE LIABLE TO ANYONE, INCLUDING THIRD PARTIES, FOR INCIDENTAL, CONSEQUENTIAL OR SPECIAL DAMAGES OF ANY KIND INCLUDING BUT NOT LIMITED TO, BREACH OF WARRANTY, LOSS OF USE, LOSS OF PROFIT, INTERRUPTION OF BUSINESS OR LOSS OF GOODWILL.